



Calhoun: The NPS Institutional Archive
DSpace Repository

Theses and Dissertations

1. Thesis and Dissertation Collection, all items

2007-03

A comparable market study of RFID for
manual item-level accountability inventory
and tracking systems

Courtney, Valencia V.

Monterey, California. Naval Postgraduate School

<http://hdl.handle.net/10945/3553>

This publication is a work of the U.S. Government as defined in Title 17, United States Code, Section 101. As such, it is in the public domain, and under the provisions of Title 17, United States Code, Section 105, is not copyrighted in the U.S.

Downloaded from NPS Archive: Calhoun



Calhoun is the Naval Postgraduate School's public access digital repository for research materials and institutional publications created by the NPS community. Calhoun is named for Professor of Mathematics Guy K. Calhoun, NPS's first appointed -- and published -- scholarly author.

Dudley Knox Library / Naval Postgraduate School
411 Dyer Road / 1 University Circle
Monterey, California USA 93943

<http://www.nps.edu/library>



**NAVAL
POSTGRADUATE
SCHOOL**

MONTEREY, CALIFORNIA

THESIS

**A COMPARABLE MARKET STUDY OF RFID FOR
MANUAL ITEM-LEVEL ACCOUNTABILITY
INVENTORY AND TRACKING SYSTEMS**

by

Valencia V. Courtney

March 2007

Thesis Advisor:

Glenn Cook

Second Reader:

Richard Bergin

Approved for public release; distribution is unlimited.

THIS PAGE INTENTIONALLY LEFT BLANK

REPORT DOCUMENTATION PAGE			<i>Form Approved OMB No. 0704-0188</i>
Public reporting burden for this collection of information is estimated to average 1 hour per response, including the time for reviewing instruction, searching existing data sources, gathering and maintaining the data needed, and completing and reviewing the collection of information. Send comments regarding this burden estimate or any other aspect of this collection of information, including suggestions for reducing this burden, to Washington headquarters Services, Directorate for Information Operations and Reports, 1215 Jefferson Davis Highway, Suite 1204, Arlington, VA 22202-4302, and to the Office of Management and Budget, Paperwork Reduction Project (0704-0188) Washington DC 20503.			
1. AGENCY USE ONLY (Leave blank)	2. REPORT DATE March 2007	3. REPORT TYPE AND DATES COVERED Master's Thesis	
4. TITLE AND SUBTITLE A Comparable Market Study of RFID for Manual Item-Level Accountability Inventory and Tracking Systems			5. FUNDING NUMBERS
6. AUTHOR(S) Valencia V. Courtney, LCDR, USN			
7. PERFORMING ORGANIZATION NAME(S) AND ADDRESS(ES) Naval Postgraduate School Monterey, CA 93943-5000			8. PERFORMING ORGANIZATION REPORT NUMBER
9. SPONSORING /MONITORING AGENCY NAME(S) AND ADDRESS(ES) N/A			10. SPONSORING/MONITORING AGENCY REPORT NUMBER
11. SUPPLEMENTARY NOTES The views expressed in this thesis are those of the author and do not reflect the official policy or position of the Department of Defense or the U.S. Government.			
12a. DISTRIBUTION / AVAILABILITY STATEMENT Approved for public release; distribution is unlimited			12b. DISTRIBUTION CODE
13. ABSTRACT (maximum 200 words) This thesis focuses on a return on investment (ROI) strategy for radio frequency identification (RFID) item-level tagging of assets by organizations that maintain manual inventory and tracking systems. The basis of strategy exists in leveraging benefits offered in repeated use of automated identify data and capture technology, RFID. The business model used for this thesis focuses on organizations that provide reference material management services (RMMS) (e.g. library reference material, employee privacy information records, laptops, etc) to internal and external customers. Although technology has created a means to digitized reference material, many organizations are required to maintain manual record systems for various reasons. In addition, a digitized capability does not address the issue of accounting for other pilferable items such as laptops, personal digital assistants, etc. Therefore, evaluating capabilities available in RFID technology could lead to strategic options for eliminating the challenges posed by the lack of item visibility that exist in a manual RMMS business processes. Strategy development will derive from lessons learned in documented RMMS case studies that implemented an RFID solution. This thesis discusses and analyzes companies in private sector industry that have reported positive ROI with tangible benefits by implementing RFID for the purpose of asset control/management.			
14. SUBJECT TERMS RFID, passive tag, item-level tracking, KVA, strategy, modeling			15. NUMBER OF PAGES 111
			16. PRICE CODE
17. SECURITY CLASSIFICATION OF REPORT Unclassified	18. SECURITY CLASSIFICATION OF THIS PAGE Unclassified	19. SECURITY CLASSIFICATION OF ABSTRACT Unclassified	20. LIMITATION OF ABSTRACT UL

THIS PAGE INTENTIONALLY LEFT BLANK

Approved for public release; distribution is unlimited.

**A COMPARABLE MARKET STUDY OF RFID FOR MANUAL ITEM-LEVEL
ACCOUNTABILITY INVENTORY AND TRACKING SYSTEMS**

Valencia V. Courtney
Lieutenant Commander, United States Navy
B.S., University of Maryland, 1992

Submitted in partial fulfillment of the
requirements for the degree of

**MASTER OF SCIENCE IN
INFORMATION TECHNOLOGY MANAGEMENT**

from the

**NAVAL POSTGRADUATE SCHOOL
March 2007**

Author: Valencia V. Courtney

Approved by: Glenn Cook
Thesis Advisor

Dr. Richard Bergin
Second Reader

Dr. Dan C. Boger
Chairman, Department of Information Sciences

THIS PAGE INTENTIONALLY LEFT BLANK

ABSTRACT

This thesis focuses on a return on investment (ROI) strategy for radio frequency identification (RFID) item-level tagging of assets by organizations that maintain manual inventory and tracking systems. The basis of strategy exists in leveraging benefits offered in repeated use of automated identify data and capture technology, RFID. The business model used for this thesis focuses on organizations that provide reference material management services (RMMS) (e.g. library reference material, employee privacy information records, laptops, etc) to internal and external customers.

Although technology has created a means to digitized reference material, many organizations are required to maintain manual record systems for various reasons. In addition, a digitized capability does not address the issue of accounting for other pilferable items such as laptops, personal digital assistants, etc. Therefore, evaluating capabilities available in RFID technology could lead to strategic options for eliminating the challenges posed by the lack of item visibility that exist in a manual RMMS business processes. Strategy development will derive from lessons learned in documented RMMS case studies that implemented an RFID solution. This thesis discusses and analyzes companies in private sector industry that have reported positive ROI with tangible benefits by implementing RFID for the purpose of asset control/management.

THIS PAGE INTENTIONALLY LEFT BLANK

TABLE OF CONTENTS

I.	INTRODUCTION.....	1
	A. STATEMENT OF PROBLEM FOR LEVERAGING RFID TECHNOLOGY	2
	B. ASSUMPTIONS.....	3
	C. METHODOLOGY	3
	D. THESIS OUTLINE.....	5
II.	RFID TECHNOLOGY.....	7
	A. HARDWARE	9
	1. Readers.....	9
	2. Reader Antennas.....	10
	3. Tags	11
	4. Sensors	17
	5. Controller/Communication Interface	17
	6. Back-End System/Server.....	18
	B. SOFTWARE.....	19
	1. Middleware Vendor/Support.....	19
	C. INNOVATION/TRENDS.....	20
	1. RFID Technology vs. Bar Code Technology	20
	2. Consumer Concerns.....	22
	3. Conclusion	23
III.	STRATEGIC MODEL.....	25
	A. ANALYZE WORKFLOW PROCESS – KNOWLEDGE VALUE ADDED	25
	1. Where to Start.....	25
	B. RESEARCH TECHNOLOGY THAT MEETS REQUIREMENTS.....	27
	1. Studies	27
	2. Conferences/Trade Shows	28
	3. Developing a To-Be Model.....	29
	4. Software Simulation.....	32
	C. CONDUCT COST BENEFIT ANALYSIS FOR RFID FEASIBILITY...32	32
IV.	STRATEGY DEMONSTRATION	35
	A. STAKEHOLDERS	37
	1. IT and Information Assurance Division	37
	2. Internal Customers	38
	3. RMMS Office	38
	4. External Customers	39
	B. BUSINESS CONTEXT/DRIVERS	39
	C. ANALYZING WORKFLOW PROCESS	42
	D. RESEARCH	50
	1. Case Studies.....	51
	a. Academic Institution.....	51

	b.	<i>Law Firm</i>	53
	c.	<i>Circuit Court</i>	55
2.		Trade Studies and Conferences	56
	a.	<i>RFID Analysis from RAND Corporation Global Technology Revolution 2020... Research Report</i>	56
	b.	<i>Aberdeen Group Finding on Manufacturing Industry RFID Perception and Use</i>	57
	c.	<i>Trade Conference</i>	58
3.		To-Be Model	59
	a.	<i>Risk Assessment</i>	62
	b.	<i>Technology Maturity</i>	66
	c.	<i>Integration</i>	66
	d.	<i>Learning Curve on Training/Operation</i>	66
4.		To-Be Model Simulation	67
E.		CONDUCT COST/BENEFIT ANALYSIS	67
	1.	Risk	67
	a.	<i>Hardware Performance</i>	68
	b.	<i>Software</i>	68
	c.	<i>Technical Feasibility</i>	69
	2.	Benefits	69
	3.	Return on Investment	70
	a.	<i>Estimated Cost to Implement RFID</i>	70
	b.	<i>Cost of Current System</i>	71
V.		CONCLUSION	73
	A.	DISCUSSION	73
	B.	RECOMMENDATIONS	74
		APPENDIX A – “AS IS” WORKFLOW MODEL: ITEM CHECKOUT SEGMENT ..	75
		APPENDIX B – “AS IS” WORKFLOW MODEL: ITEM CHECK-IN AND INVENTORY SEGMENTS	77
		APPENDIX C – “AS IS” INVENTORY AND ITEM CHECKOUT KVA ANALYSIS SPREADSHEETS	79
		APPENDIX D – “TO BE” WORKFLOW MODEL: ITEM CHECKOUT SEGMENT	81
		APPENDIX E – “TO BE” WORKFLOW MODEL: ITEM CHECK-IN AND INVENTORY SEGMENTS	83
		APPENDIX F – “TO BE” INVENTORY AND ITEM CHECKOUT KVA ANALYSIS SPREADSHEETS	85
		APPENDIX G – MIND MAP OF RFID IMPLEMENTATION OPTIONS	87
		APPENDIX H – UTILITY TREE OF QUALITY ATTRIBUTES	89
		LIST OF REFERENCES	91
		INITIAL DISTRIBUTION LIST	95

LIST OF FIGURES

Figure 1.	RFID ...Forecast and Analysis (From: Boone, 2004)	7
Figure 2.	Example of RFID system components (From: Intermec, 2005a)	8
Figure 3.	Example of Readers (From: Google.com images).....	9
Figure 4.	Block diagram example of reader (From: Butler & Nti, 2005)	9
Figure 5.	Examples of Antennas (From: Intermec, 2005a).....	10
Figure 6.	Antenna linear and circular polarization (From: Lahiri, 2006).....	11
Figure 7.	Example of Transponder Inlay (From: Intermec, 2005a)	11
Figure 8.	Diagram of load modulation communication. (From: Want, 2006)	13
Figure 9.	Diagram of backscatter communication (From: Lahiri, 2006)	13
Figure 10.	Example of smart label (From: DATA & Corporate Culture Group, 2007) ..	14
Figure 11.	Example of active tag (From: Lahiri, 2006)	16
Figure 12.	Examples of Servers (From: Google.com images).....	18
Figure 13.	RFID tag cost vs. volume (From: TagSense.com, 2006).....	21
Figure 14.	KVA model (From: Housel & Bell, 2001)	26
Figure 15.	Maturity level in RFID implementation (From: Blossom, 2005).....	29
Figure 16.	Sample of RFI template (From TEC, 2004)	33
Figure 17.	LMVO organization chart.....	36
Figure 18.	Segment of Inventory sub-process in As-Is RMMS business process	43
Figure 19.	KVA results of the As-Is item checkout sub-process	45
Figure 20.	KVA results of the As-Is inventory sub-process	46
Figure 21.	Mind map of brainstorming best method for implementation	60
Figure 22.	Segment of inventory and checkout sub-processes in the “To-Be” model.....	61
Figure 23.	Utility tree and scenarios for To-Be model.....	62
Figure 24.	Screen capture of “To-Be” simulation	67
Figure 25.	Example of RFID system functionality checklist (From: Intermec, 2005b) ..	68

THIS PAGE INTENTIONALLY LEFT BLANK

LIST OF TABLES

Table 1.	Passive tag common frequency/wavelength (From: Garfinkel & Rosenberg, 2006)	15
Table 2.	EPC RFID Classes (From: Garfinkel & Rosenberg, 2006)	15
Table 3.	RFID Generation 1 versus Generation 2	16
Table 4.	RFID advantage over Bar Code	21
Table 5.	Sample steps to evaluate system suitability	31
Table 6.	Example of business process statistics	38
Table 7.	Cycle times revealed from “As Is” map workflow	44
Table 8.	As-Is inventory facts	47
Table 9.	Cost calculations for KVA analysis sub-processes	48
Table 10.	As-Is item checkout facts	49
Table 11.	High priority scenarios	63
Table 12.	Quality factors related to functional requirements	65
Table 13.	Feasibility of To-Be as RFID candidate	65
Table 14.	Example of cost estimate for RFID implementation	71
Table 15.	Estimated acquisition and monthly cost of “To Be” operating cost by facility	71
Table 16.	Estimated monthly cost of “As Is” operating cost by facility	72

THIS PAGE INTENTIONALLY LEFT BLANK

ACKNOWLEDGMENTS

Thanks to family and friends for believing in and supporting my efforts during this challenging but rewarding period of my naval career. A special thanks to the NPS instructors and professors who provided direction in completing this research, especially the uninhibited freedom to derive an artifact that is relevant to current technology. Finally to the organizations and business that sacrificed the time from their busy schedules to conduct interviews, many thanks for your patience.

THIS PAGE INTENTIONALLY LEFT BLANK

I. INTRODUCTION

The increases in recently reported incidents of missing or stolen pilferable assets have marked a significant need for better control in asset management. Radio frequency identification technology addresses the efficiency and effectiveness issue of asset management by offering capabilities that enhance visibility of assets within an organization. The need for effective and efficient asset management is the key business driver for business processes relating to reference material accountability. The type of items that may fall into this category are law firm client records, library reference material, laptops, employee security profile records, patient records at medical facilities, etc. The following highlight a few reported incidents regarding the theft or loss of some of these items:

- In August of 2006, the Library Journal reported that Edward Forbes Smiley III admitted to stealing rare maps from various libraries to the tune of over \$3 million after being caught in his failed attempt to steal a rare map from a library at Yale University (Albanese, 2006).
- On 3 May 2006 the Veteran's Administration reported the theft of a laptop that stored over 26 million digital records/files of privacy act information. The laptop was stolen from the residence of an employee who regularly transported the device to and from work in order to continue work from home (Lee & Brulliard, 2006).
- "...Ameriprise, of course, isn't the only company that has seen its laptops walk off... Verizon Communications, Boeing and Fidelity are among a number of companies that have been victimized by laptop thefts recently. What's more, the security threat doesn't emanate only from laptop thefts -- the ubiquity of portable and easily poachable devices like jump drives, Blackberries and MP3 players seem to make the next exposure of sensitive data a question of when, not if."(Annett, 2006).

- In July 2002, an audit report by the Naval Audit Service revealed the results of an investigation on the Navy's Pacific Fleet (PACFLT) command in Hawaii. Over 180 laptops/desktops reported missing, some of which may have been used to process classified data. The missing units were attributed to poor IT asset management procedures some of which are paper/manual-based inventory database systems (Kakesako, 2002).

The issue of stolen or loss information assets has been reported more frequently over the last several years by both federal agency and private industry. In many cases, these items held sensitive or Privacy Act information. According to a June 2006 technology brief by J. Gold Associates, reporting a breach of privacy information can be quite costly for a private company both financially and a loss of consumer trust (J. Gold Assoc., 2005). A measure that aids in reducing information breaches that is strongly recommend by Information Assurance experts and Privacy Act advocates alike involves security managers employing the practice of encrypting data stored on electronic devices.

Security managers who invest time in reviewing and implementing measures toward their business practices for protecting information and assets typically have a more robust physical security program (Mairs, 2002). The ideal robust capability would an ability to remotely disable an electronic reference material asset and/or locate the physical location of any tagged reference item. At present, RFID systems can perform the ability of locating the physical location of tagged items, which will be discussed in detail. Various organization both private and government are conducting feasibility studies to determine the most effective ways to leverage RFID technology in other ways to track and manage controlled/high-value item-level assets.

A. STATEMENT OF PROBLEM FOR LEVERAGING RFID TECHNOLOGY

The objective of this thesis is to research and develop a strategy that will identify potential benefits of leveraging RFID technology. Manual inventory and tracking systems used for item-level accountability, e.g. patient records in a medical facility, are the types

of business processes evaluated when considering what advantages RFID technologies offer. The results of this research provide a strategic roadmap allowing organizations to determine if the business process under consideration is a good candidate for RFID technologies based on a cost/benefit analysis at the item level.

B. ASSUMPTIONS

Several case studies from private sector industries discuss their employment of RFID item-level tagging for managing asset control/monitoring. The benefits documented in these case studies offer compelling justification to conduct a thesis research for organizations maintaining manual inventory systems. Specific benefits relate to leveraging potential opportunities that exist in current RFID technology towards personnel and physical security system/procedures. The research required to develop a RFID strategy to fit the organization's needs, often reveals if identified items within the organization's workflow are technically feasible candidates for this type of technology. The strategy approach relates to the guideline illustrated by author Sandip Lahiri's book, *RFID Sourcebook*:

- (1) Determine impacts of RFID technology.
- (2) Ensure understanding and buy-in from senior management.
- (3) Form high-level master plan from which business justification, deployment strategies, and other policies can derive.
- (4) Ensure cross-functional support (Lahiri, 2006).

C. METHODOLOGY

The first part of the thesis outlines a strategy model for identifying business processes that may be suitable for leveraging RFID technology in organizations performing manual data capture for inventory and tracking of controlled assets. The

strategy focuses on organizations (medical facilities, law firms, libraries, etc.) that manage items in reference material management services (RMMS). The strategy model addresses:

- current and a desired end-state business process for item-level visibility
- business justification based on cost/benefit analysis
- sources that aide in matching vendor to end-state requirements

The second part of the thesis demonstrates the strategy model on a mock RMMS organization, i.e. organizations that track the status/location of records, files, books, etc. Emulating common business practices used by organizations performing manual data capture for item-level tracking will allow application of relevant research findings by similar organizations. The construct of the mock organization reflects on real organization however with altered details in order to preserve anonymity.

To analyze the current the current and desired future state business process, “As Is” and “To Be” workflow respectively, application of the Knowledge Value Added (KVA) method (Housel & Bell, 2001) used to determine the return on knowledge (ROK) i.e. return on interest (ROI) from human and IT investment capital. Diagrams of workflow models derived with Mind Manager® (Mindjet Corporation, 2007) software application. This collaborative tool allows capturing work efforts in a visual context for brainstorming, creating decision trees, mapping parallel/sequential process, etc. After conducting the KVA analysis, the next phase of research entails conducting post-implementation interviews with organizations from chosen case studies. The interviews address problem areas/bottlenecks identified in the “As Is” KVA analysis. Information gathered from interviews assist in ensuring that the “To Be” model reflects improvements from lessons learned, pitfalls to avoid, strategy guidance or any other issues not considered.

The quality requirements for the “To Be” model derive from scenario-based profiles consisting of usage, maintenance and security use cases for the “To Be” system.

The scenarios identify common capabilities sought after by organizations searching for improvements in item-level accountability. Using scenarios provide a way to associate a quality attribute to functional requirements and thus the ability for measuring quantitative and qualitative results when a scenario is simulated. This approach mirrors a technique borrowed from author Jan Bosch's book, "*Design and Use of Software Architecture: Adopting and evolving a product-line approach*".

The software simulation of the "To Be" model developed for this thesis shows what the design layout and item interaction of what a potential implementation would look like. The simulation provides a means to evaluate vendors for determining the best fit in meeting requirements and desired end-state. Trade studies, case studies and conference material are the source of criteria for evaluating vendors. The top three "best fit" vendors provide the baseline for developing a cost/benefit analysis (CBA).

The conclusion of the thesis research entails drafting a business justification from the CBA for leveraging RFID technology for item-level tracking of reference material items. The business justification will synthesize the findings of the research and provide a high-level outline of the strategy used to derive the findings. The strategy outline will allow organizations with a similar business process the capability of applying the findings of this thesis when considering a RFID implementation.

D. THESIS OUTLINE

This thesis consist of sections I through V. Section I introduces a discussion on the difficulties faced by organization in managing pilferable items that are regarded as controlled/high-value assets and how RFID technology can be leveraged to address this issue. Section II describes the general fundamentals of RFID technology; the components that comprise a functional system, trends/innovation and a comparison to the barcode (its competitive product-line).

Section III outlines a logical strategy model for determining if a business process is a viable candidate for leveraging RFID technology as a means to improve the process.

This section begins by discussing the KVA method; analyze the workflows of a business process, which results in tying IT assets to intellectual capital. A methodology developed by Dr. Tom Housel and Arthur H. Bell provides decision makers with a more relevant alternative to traditional accounting methods when considering IT investment options.

The completion of the KVA analysis the discussion moves to identifying requirements for improving the process, which leads to a “To Be” model. The section goes to discuss the importance of identifying functional requirements and a simple way in how to accomplish this task. This section also suggest sources for gathering information on lessons learned by similar organizations, matching vendors to requirements and then ends with a discussion in cost/benefit analysis for business justification. Section IV demonstrates the strategy model by using a mock organization. The thesis concludes in section V that summarizes research findings and makes recommendations for applying them.

II. RFID TECHNOLOGY

The volume of information available on Radio Frequency Identification (RFID) technology from sources such as vendors, journals, webinars, and the internet is quite extensive. Getting familiar with terminology such as transponder (microchip), interrogator (reader), form factor (product type, i.e. label, tag, card, etc) and the like can be an obstacle in understanding product information for devices offered in this wireless technology. Granted as the products and services (hardware and software) offered continue to evolve toward standards and become more prolific in the consumer market, buyers will become more knowledgeable in RFID terminology and application.

One indication that UHF RFID technology will likely become more common in the consumer market was the 2004 ratified world-wide EPCglobal standard for read-write UHF RFID technology known as UHF Class-1 Gen2 (EPCglobal US, 2006). Globally accepted standards in technology usually lead to lower cost to the end-user. The price of passive tag price estimated to be down to .05¢/tag by 2008 (Figure 1) according the Federal Trade Commission. Cost and an absence of standards have been key factors in

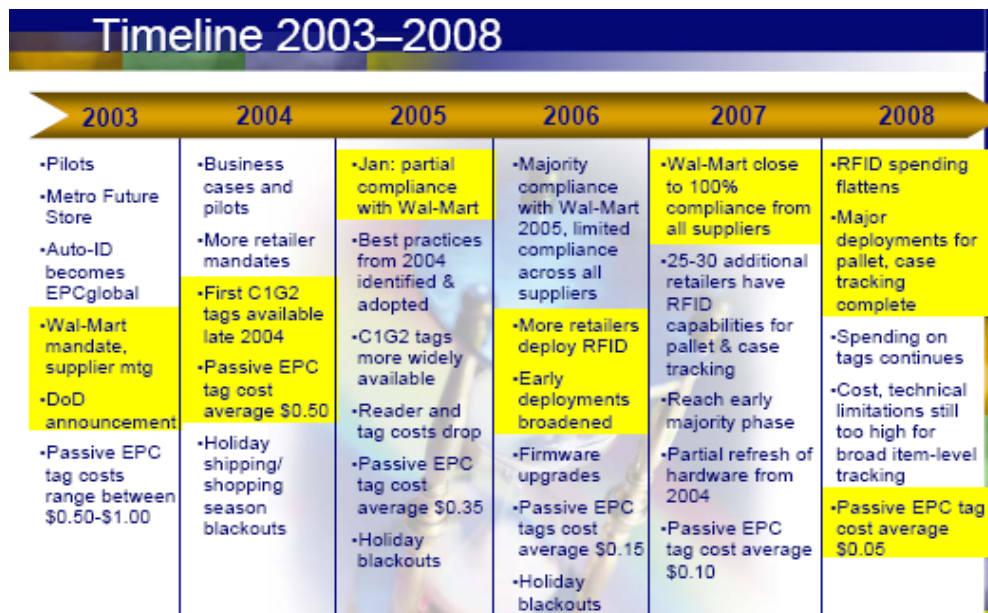

Figure 1. RFID ...Forecast and Analysis (From: Boone, 2004)

user reluctance to adopt RFID as an automated identify data and capture (AIDC) capability in item-level visibility for applicable business processes.

The remainder of this section discusses the components that comprise a RFID system (Figure 2). By using radio frequency (RF) waves at low, high, ultra-high, and microwave frequencies (LF, HF, UHF, and MW respectively) these components are applicable to all RFID technologies; access control, AIDC, track/trace, etc. The basic system has two components; the tag (a substrate with antenna inlay attached to a transponder) and the interrogator with attached antenna.

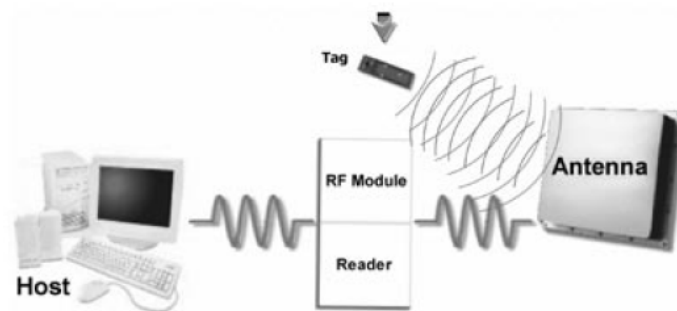

Figure 2. Example of RFID system components (From: Intermec, 2005a)

Other components that supplement the system and enable refined processing of raw data that has passed from tag to interrogator may include middleware and server, sensors/actuator, and communication interfaces. The section ends with a brief discussion on comparing bar code to RFID capability; viewed by some as the next evolution to the bar code.

A. HARDWARE

1. Readers



Figure 3. Example of Readers (From: Google.com images)

A typical system may employ several kinds of readers such as hand-held, desk station, or access portals (Figure 3). Readers use a RF signal to read tags and obtain the information stored on them as shown in the block diagram below (Figure 4). The reader with attached to an antenna generates a RF field. When a tag enters the RF field, information stored on the tag is decoded by the reader and sent to an edge or back-end server.

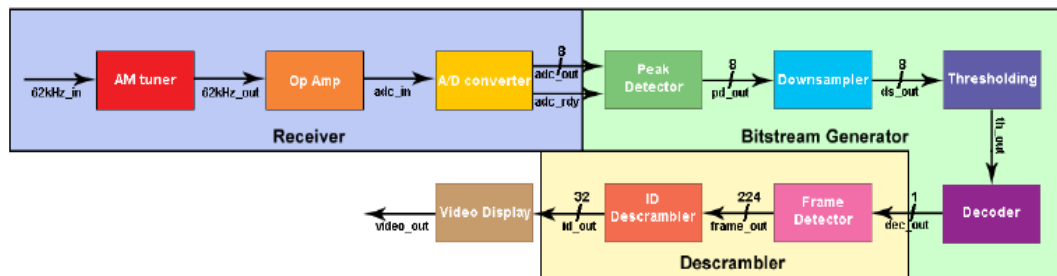

Figure 4. Block diagram example of reader (From: Butler & Nti, 2005)

Readers used by organizations could include a portable device for reading tagged items on the shelves when inventorying or locating missing and misplaced items; desk stations used for checking items in or out; and walk-through exit with sensors which could trigger events such as sound an alarm or open access, etc. Readers are manufactured to operate in three types of environments; single reader, multiple readers

(2- 49) that are within 1 km radius apart; or dense readers (50 or more) that are within 1 km radius apart. A business office, tracking files, in a controlled area might use a single reader; a library would use a multi-reader set up; and a large distribution center might have over 60 readers for tracking item movement.

2. Reader Antennas



Figure 5. Examples of Antennas (From: Intermec, 2005a)

Antennas are a crucial component in the RFID system, as they will determine the width and distance, i.e. footprint, of the read zone between reader and tag. Some readers have internal antennas (hand-held) while most tend to have external types (Figure 5). The polarization (i.e. the direction of the electric field in a electromagnetic wave, often depicted as an ellipse extending from the antenna) of the antenna will determine the shape of its footprint. If the antenna has a linear polarization, the footprint will have a long narrow ellipse read zone and requires vertical tag placement on items. For flexibility in tag orientation on items, a circular antenna allows tag reading from a vertical, horizontal and diagonal placement with a wider ellipse read zone, the trade-off is shorter read range. The impacts on tag orientation for each type polarization shown in the tag placement diagram (Figure 6).

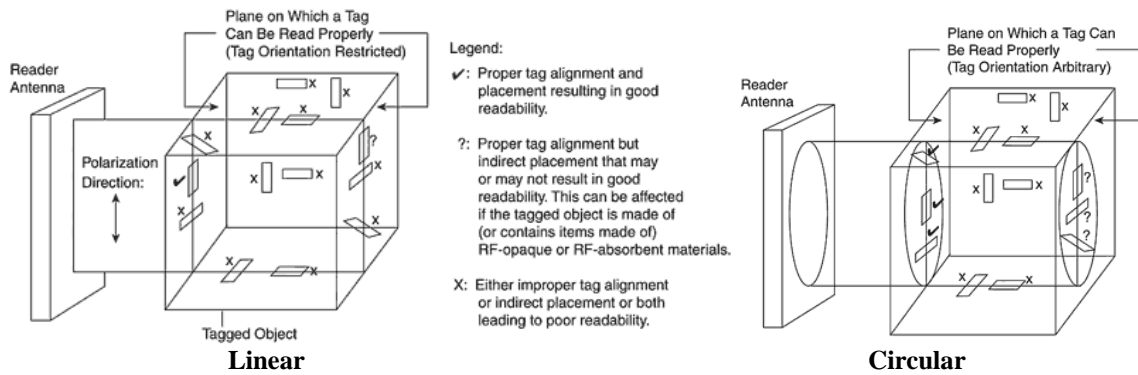

Figure 6. Antenna linear and circular polarization (From: Lahiri, 2006)

One major concern that end-users have about antennas relates to limiting the propagation of RF harmonic to ensure management of information security. According to an article from RF Design magazine on embedded RFID readers it“... is usually necessary to have filtering after the power amplifier to suppress conducted harmonics” from antennas (Reynolds & Weigand, 2005). The article also references an option of choosing an antenna that has an internal switch, which produces low harmonic output, and eliminating the need for harmonic filtering. The trade-off for a tag with an antenna switch vice a non-switch could be more costly because more capability usually translates to more cost.

3. Tags

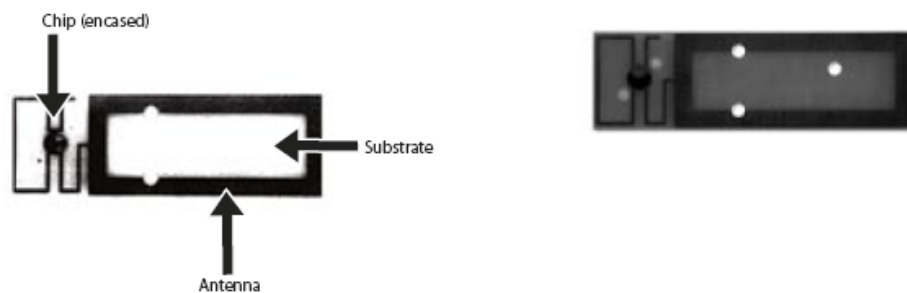

Figure 7. Example of Transponder Inlay (From: Intermec, 2005a)

Based on the application of a RFID tag, it can vary in size and shape; paper-thin, small enough to fit inside a bottle top or as thick and large as a brick. A tag consists of a substrate (flexible material base made of laminate, paper, plastic, etc) inlaid with an antenna and a microchip (Figure 7). The tag has a typical storage capacity of at least 64 bits, some up to 1024 bits. Tags can operate in one of three modes, passive, semi-passive, or active. The tag's storage capability will be either read-only, write-once-read-many (WORM), or rewritable.

Passive tags are typically smaller in size and cost less than semi-passive or active tags because they don't have a power assisted (battery) component built into their structure. Their power (tag activation) derived from the RF wave transmitted by reader. The frequency design of the tag will determine how a passive tag obtains its power. It occurs in one of two ways:

load modulation (near-field communication (NFC) with reader antenna) for tags operating in LF and HF frequencies – tag uses energy from the electric component of the electromagnetic (EM) field created by the reader's antenna to modulate the magnetic component in the EM field (Figure 8). Modulation corresponds to the ones and zeros that represent data stored on tag. The reader detects the changes in the magnetic field amplitude and converts changes into ones and zeros.

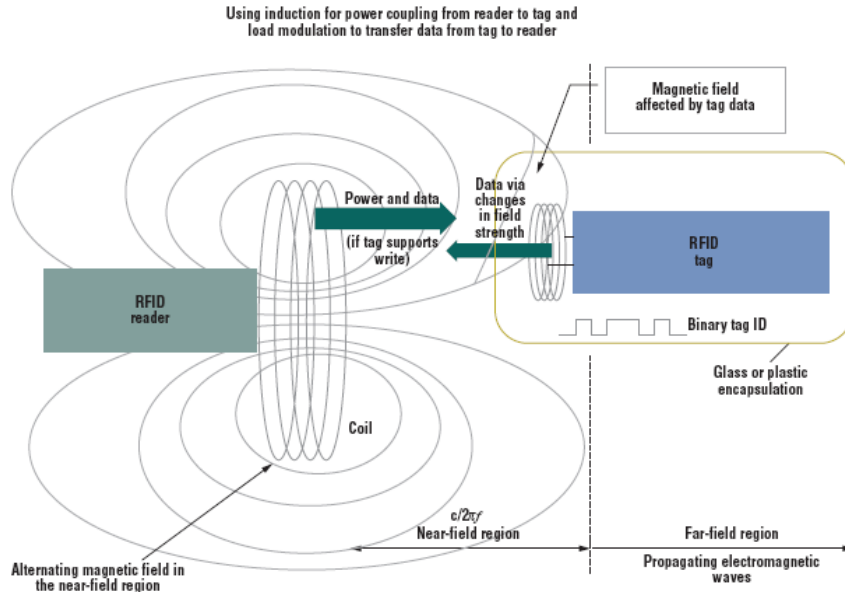

Figure 8. Diagram of load modulation communication. (From: Want, 2006)

backscatter (far-field communication (FFC) with reader antenna) for tags operating in the UHF and MW frequencies - tag use the energy in the EM field created by the reader's antenna to reflect back a RF wave (Figure 9) carrying a copy of the data stored on the tag for digital to analog conversion by the reader.

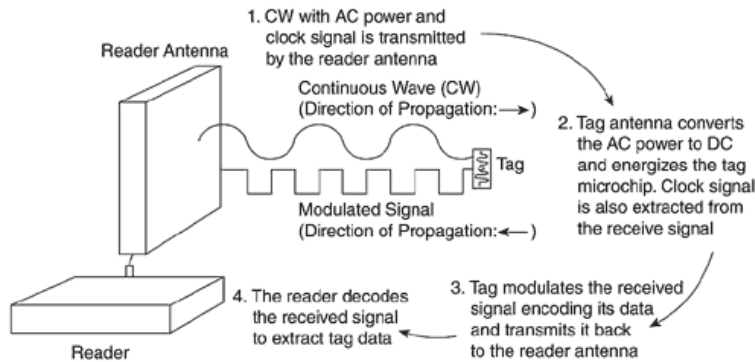

Figure 9. Diagram of backscatter communication (From: Lahiri, 2006)

Read-only tags have a unique identification number encoded at the time of manufacturing and purchased by an end-user as ready-to-use product. This type of tag would be applicable in a small closed-loop RFID system. An example of this application

could be small organizations that only use AIDC information in-house, for instance a clinic tracking patient records with staff of 40 doctors.

WORM tags have information encoded once by the end-user when enabled for initial use. These tags are a good fit for organizations using bar codes but need to implement RFID to gain increased efficiency of item visibility while maintaining existing bar code partnerships. Most RFID readers can read bar code which allows organizations to easily transition existing bar code label to an encoded (transponder inlay) smart-label (Figure 10). The main advantage of this tag over read-only tags relates to flexibility for the end-user to write information based their customized requirement vice accepting vendor pre-assigned information.



Figure 10. Example of smart label (From: DATA & Corporate Culture Group, 2007)

Rewritable tags have information encoded by the end-user when enabled for initial use and then changed or added as needed in accordance with the use of tag application. Part of this tag has a reserved storage area to allow encoding of the item identification number of the item once after which protected from future overwrite. This helps to prevent accidentally overwriting the identification number during subsequent write events. An example business application for this type of tag would exist with a requirement to log the history on an item's chain of custody.

The functionality of passive tags are constrained by many factors such as frequency/wavelength (Table 1); the type of EPC device classes (Table 2) it belongs to; and its transponder generation (Table 3) just to name a few. The read range of a passive

Frequency Band	Description	Wavelength
125-134 KHz	LF	2.4 km
13.553-13.567 MHz	HF	22 m
860-960 MHz	UHF	32.8 cm
2.45 GHz	MW	12.5 cm

Table 1. Passive tag common frequency/wavelength (From: Garfinkel & Rosenberg, 2006)

tag is also subject to a combination of factors associated with the reader. Factors for the NFC tag design relate to "...the sensitivity of the reader, the transmit power of the reader, the Q-factor of the tag, the power consumption of the tag IC chip, the size of the reader antenna, and antenna and the ratio of the tag antenna size to the reader antenna size. A crude rule of thumb is to say that the reading range is limited to 1.5 times the diameter of the reader antenna." For FFC tag design "the reader sensitivity, the reader power, the power consumption of the tag IC chip, the radar scattering cross section of the antenna, the efficiency of the antenna, and the gain of the reader antenna and tag antenna." (TagSense.com, 2006) The Q-factor is the quality factor that indicates the effect of electrical resistance, i.e. comparison of a system's frequency oscillation to its energy dissipation over time.

EPC Device Class	Definition	Programming
Class 0	Read only passive tags	Encoded by mfg'r
Class 1	WORM passive tags	Encoded by end-user
Class 2	Rewritable passive tags	Reprogrammable
Class 3	Semi-passive tags	
Class 4	Active tags	
Class 5	Readers	

Table 2. EPC RFID Classes (From: Garfinkel & Rosenberg, 2006)

Feature	Generation 1	Generation 2
Frequency	860-930 MHz	860-960 MHz
Memory capacity	64 or 96 bits	96-1024 bits
Field-programmability	Yes	Yes
Verify data write	No	Yes
Password size (bits) to kill tag	8 bits, about 1 day to brute force	32 bits, about 1 month to brute force
Reader reliability	Problematic, “ghost reads”	Reduced/eliminated “ghost reads, dense read ability-multiple readers active at same time
Global standards	No	Yes

Table 3. RFID Generation 1 versus Generation 2

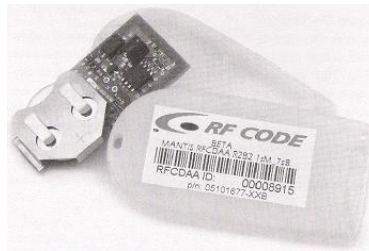

Figure 11. Example of active tag (From: Lahiri, 2006)

Active and semi-passive tags construction consist of a power source (Figure 11) which means they do not require the reader to make contact first as with passive tags. These types of tags commonly used in conjunction with sensors and actuators in for real-time location systems (RTLS). When a business process requires timely information on tagged items in order to thwart an event that will have grave/serious consequences RTLS is the solution many businesses are implementing. Areas of application have occurred in the logistic, health care, and transportation industries.

The price for such visibility comes at quite a premium, approximately \$5 to \$100 dollars per tag. The business model in this thesis will center on a closed-loop RFID system for RMMS item tagging. Therefore, while enhancing the visibility of these items

is the primary objective toward improved operations efficiency, incurring a \$5+ per tag cost is not part of the intended direction for the strategy model. However, options will include considerations for components that will allow future upgrades for active tag integration.

4. Sensors

Various sensor and sensor networks have been in use for quite some time, e.g. smoke detectors, temperature monitors, motion detectors and the like. Integrating sensors with active/semi-passive RFID tags extends monitoring and actuator operations to levels not previously capable. Given the on-board power in these tags, they can trigger events to activate the reader vice waiting for activation. An example of leveraging RFID with sensors; agriculture can use environment designed active tags with temperature or moisture sensors which will trigger a reader to initiate the controls for a specific section of an irrigation system. The impact this type of application has on a business process is virtually atomic level management of the organization's process value chain; an optimal opportunity for continuous process improvement.

5. Controller/Communication Interface

The controller manages the communication interface software, which provides the system user and other external devices such as sensors, tags, antennas, etc the ability to access/interact with readers. An analogy of the controller in the RFID system relates to a print driver for a printer; without it, external devices would not know what commands to use for interacting with the printer. Some readers are embedded with a controllers and graphical user interface (GUI), otherwise the controller is a separate unit and GUI.

6. Back-End System/Server



Figure 12. Examples of Servers (From: Google.com images)

The server component, considered the heart of some comprehensive RFID systems, acts as the communications gateway among the various components (Boss, 2004). The back-end server (host computer) can tie the RFID reader(s) to an organization's ERP information system by using a comparable standard server (Figure 12) found in almost every enterprise across the world. The server and middleware, discussed below, make up one of the key components in the RFID system. The server receives information from one or more of the readers and exchanges information with the database that contains tagged item's data. When purchasing a RFID server (at costs as much as \$15,000) more than two-thirds of that price goes toward the software (Boss, 2004).

Sun systems such as the Sun Fire or Sun Blade can be used along with any x86 server running Microsoft Windows Server. Dell, HP, and IBM are some of the major producers of compatible servers. The specifications of the server will vary depending on the RFID software used and the volume of AIDC required for a RFID system implementation. One of the most critical requirements would be the amount of hard-drive capacity needed for storing tagged item information received from the reader(s). A separate storage system, such as a storage-attached network, devices installed for use with large databases.

B. SOFTWARE

1. Middleware Vendor/Support

Middleware is the software loaded on the RFID host computer, which bridges the communication between the RFID reader devices and the ERP information system. In some cases organization opt not have the RFID host computer communicate/write to the ERP database due to integrity requirements. As of this writing the database in several of the larger ERP, applications don't/can't accept raw data from RFID readers. Therefore, to ensure integrity from this new integration organization must also host the RFID database in addition to the ERP database.

The middleware software provides an interface for various reader devices and assists with the filtering, aggregation, and routing of RFID data from the reader devices to enterprise information systems. In particular, Java System RFID Software is Sun's standards-based RFID middleware that provides all these basic functionality and the ability to operate at high levels of reliability and scalability in mission critical deployments. In addition to device and event management, the Java System RFID software provides a RFID information server and interfaces which allows the storage and integration of business events with the enterprise's business processes. The middleware has built-in business rules that monitor the data stream and direct data to appropriate enterprise systems (Sun, 2007).

A more comprehensive RFID system includes platform software. For example, the Total Asset Visibility System employed by the Department of Defense has a software platform that manages and monitors a broad spectrum of automatic identification technologies. This includes active and passive RFID, GPS, mesh networks, barcode and real-time locating systems for tracking logistics.

C. INNOVATION/TRENDS

1. RFID Technology vs. Bar Code Technology

The controversy over how much better RFID is when compared to bar code technology has generated much discussion over the years. In fact prior to EPCglobal/ISO UHF standards for RFID there was multitude of products that were not interoperable which made bar code application the only stable choice for AIDC. Implementing an emerging technology that clearly offers a faster more flexible AIDC capability was simply not worth the trade-off for costly propriety products.

Several vendors in the RFID industry have achieved level four in their compatibility maturity model (CMM) level assessments, five being the highest. A CMM level four vendor achieves greater product productivity due to reduced re-works, cycle time, schedule variability and cost with much less risk than a vendor with a lower CMM level assessment does. The customer reaps the benefits of these results in products with fewer defects, lower cost, faster delivery to market and a larger supply of the product availability. Now that vendors are able to provide these standard products and services, as evidenced by some vendors achieving cost effective CMM levels, the capabilities and benefits of RFID outweigh bar code in several ways. By and in large, RFID is viewed as the next evolution of the bar code. This being said one arguable fact remains; the cost of using RFID applications even with economies of scale will not reach the low cost of bar code applications. The average cost of a bar code label is less than 1¢ as compared to the estimated lowest “expected” cost for a passive RFID tag to be 5¢, as of this writing the average cost is approximately 30 to 40 cents. Volume purchases (Figure 13) of tags can lower the cost to as much as 10¢ for 50k units.

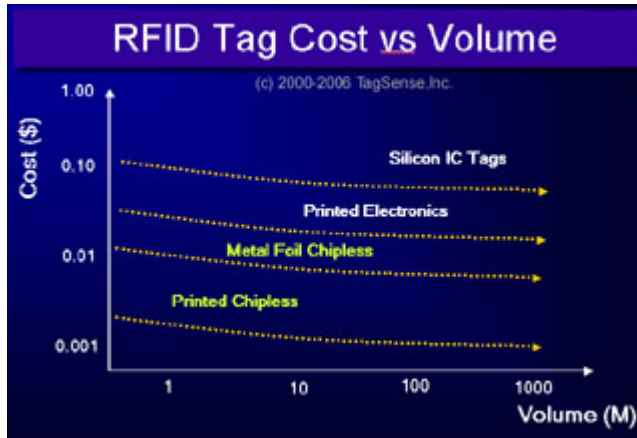

Figure 13. RFID tag cost vs. volume (From: TagSense.com, 2006)

The cost difference between the two technologies in part is due to the simplicity of bar code technology when compared to the complexity of RFID. IT analysts have predicted that as systems and technology are becoming more complex (measured in lines of code) in addressing future capability, the cost for products will reflect this trend. This is not to say that the cost of RFID products will not continue to decline from current cost as products become more standardized and available in increased supplies. Some organizations have managed to combine the strength of both technologies to achieve the flexibility for phasing in RFID implementations that meet their current and near-term strategy. Table 4 below is a basic comparative list of RFID capability over bar codes:

Feature	RFID	Bar Code
Read tag w/o direct line of sight	Yes	No
Can modify data on tag	Yes, class 2-4 tags	No
Lifecycle readability of tag	Nearly 100% for passive tags, subject to power level for active/semi-passive	Diminishes overtime or none with faulty print
Worldwide acceptance	No	Yes
Robust read range	Yes	No
Simultaneous multiple tag read	Yes	No
Affordability	Expensive but cost declining	Inexpensive

Table 4. RFID advantage over Bar Code

2. Consumer Concerns

There are issues about RFID applications that have raised concerns among consumers, businesses and the U.S. legislation alike. The paramount concern being a right to privacy on tagged items. The owner of a purchased item may be subject to unsolicited scanning practices if the tag is not “killed” at the point of sale. If personal information is stored on the tag it places the owner at risk of information theft by malicious individuals trolling for information by using a makeshift or purchased portable reader. Currently no U.S. legislation enforces laws that regulate RFID application.

The Federal Trade Commission has held workshops and sub-committee meetings to address security issues raised by consumer protection groups, academia and industry but no formal policies/laws have been established to-date (Garfinkel & Rosenberg, 2006). Current RFID right to privacy practices are self-regulated by industry; for example, some merchants either post notification of RFID scanning, “kill” the tag at point of sale, and industry leaders publish white paper/host online forums on RFID application/technology in an effort to educate consumers.

One might ask why not use an encryption method on the tag? The reason is that that it would require more lines of code on the tag that already has a limited memory space. Increasing the lines of code will drive the cost of the tag up. In addition, it is not just a matter of cost but also more the limited storage space available on the tag, at least in the case of passive tags. Active tags do have the storage capacity and can be purchased with encryption capability but ubiquitous active tags are cost prohibitive, i.e. using a \$5 dollar tag on a \$4 or less item. The most effective solution employed for addressing the privacy issue, given current technology, uses passive tags store with only non-personal information. All personal data, if necessary, would be stored on a secured information system database and use the tag’s unique identification as the database primary key.

Re-writable tags have a segment of memory reserved for setting a password, which offers some protection of data stored on the tag, but it is not very robust. During the 2006 EPCglobal U.S. conference hardware action group co-chair, Chris Diorio

briefed on a UHF class-2 Gen2 specification that will address the security piece for data protection and authenticated access control. He stated that the future, tighter security in the RFID infrastructure is likely to be layered, starting at the reader and back toward the ERP vice within the microchip (EPCglobal US, 2006).

Other issues also relate to reluctance/resistance in accepting the application of RFID as the standard. Many people correlate the use of implanting RFID tags in humans with biblical text referring to “mark of the beast”. Venturing down this road would only serve as a tangent from the focus of this thesis, however if certain events are destined to occur having a fear of the event will not prevent it from occurring.

The last issue regarding RFID vs. bar code relates more to the business sector regarding the cost obstacle in item-level tagging. In researching current and forecast trends for RFID, the rationale of a shrinking profit margin trumps the notional ubiquitous tagging of items in the future if the tag cost exceeds the item tagged. However, RFID Update (online trade source) reported that the interest by apparel, consumer electronics, and pharmaceuticals are the sources of the unexpected 2006 surge in tag consumption for item-level tagging. The report also projected that it will be some time before tag prices fall to 5¢, the limit at which some end-user may consider implementing RFID capable systems (RFID Update.com, 2006).

3. Conclusion

RFID is a fast moving train that promises long-term returns that show short payback period. Business process with bottlenecks, limited personnel and have a valid need to maintain visibility of company assets appear as likely candidate for this technology. The three major issues an organization may want to consider in light of the low hanging fruit of leveraging RFID technology:

- Impact to existing information security posture
- The value of items being considered for tagging relative to tag’s price

- Maturity of products identified as meeting requirements, i.e. ready-to use or requires customization via code changes in order to use

No doubt, other details are also required when considering RFID solutions but the three listed above will be among the top concerns. A through investigation by a team of organization stakeholders in mapping the business process they will be able to identify functional requirements. This in turn will determine if the business process is a good RFID candidate.

III. STRATEGIC MODEL

A. ANALYZE WORKFLOW PROCESS – KNOWLEDGE VALUE ADDED

1. Where to Start

In the current Information Age, the power of knowledge pays dividends to those who are able to exploit it more swiftly than their competitors are able to do so. This concept relates to a continuous improvement process mind-set. In order to have continuous improvement, organizations must be able to identify the workflow steps in their business processes. If a business has mapped the workflow of their business processes (“As Is”), they can identify bottlenecks which can be improved (“To Be”) upon by implementing certain procedures, technology to optimize the business process, or both.

After developing the “As-Is” map functional and quality requirements have been determined, a knowledge value added (KVA) analysis can reveal the assessment in the return on knowledge (ROK) from the business process. A business process takes input and transforms it into output; the transformation requires knowledge, be it human or machine. Determining how much knowledge is tied to a business process can provide a decision maker with information for strategic planning of specific capital options. This insight is derived by using a model developed by Dr. Thomas Housel from the Naval Postgraduate School, Monterey, CA and Dr. Arthur Bell from the McLaren School of Business, San Francisco, CA.

The premise of the model states by assessing core sub-processes in a larger process, the relative return on intellectual property and information technology can be derived for each sub-process (step), i.e. the ROK for these two entities. The KVA model (Figure 14) assumes:

- Output is a function of input
- No value is added if input is the same as output
- Change can be measured by the amount of knowledge required to make the change occur
- Value added is proportionate to change
- Change is proportionate to the amount of knowledge required to make the change occur

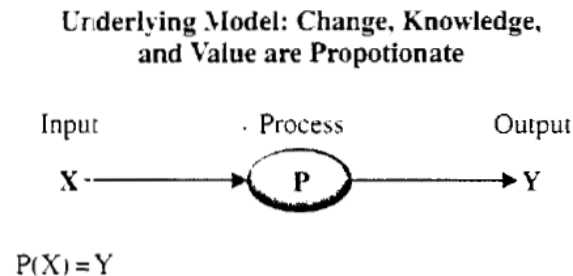

Figure 14. KVA model (From: Housel & Bell, 2001)

Conducting a KVA analysis on the “As Is” workflow will identify which step(s) is/are the least efficient in terms of ROK by assessing the amount of knowledge applied to the step. The decision maker can then use the results of the knowledge assessment to identify steps that need improvement in order to develop a “To Be” process. If the steps identified have a static redundant character in the manual system, applying IT solutions can greatly improve output and cost in the overall larger process. At this point in the workflow analysis, information is revealed that could answer the question of whether the business process shows traits of being a viable candidate for leveraging RFID capabilities. Such as, “Are there static redundant steps that can be improved for efficiency by using an auto identify data and capture application (AIDC)?”

The rationale is that automation eliminates variations in input (e.g. data key entry) thus reducing errors. It also reduces delays in the process by executing steps faster and longer than humanly possible and it can reduce the workload of humans required to run

the overall process. The last point is crucial to organizational units that have limited personnel, who are over tasked, which manifest itself as bottlenecks in the business process. RFID technology offers an effective AIDC capability to improve efficiency in a manual business process that incurs delays due to static redundant steps compounded by limited personnel resources.

B. RESEARCH TECHNOLOGY THAT MEETS REQUIREMENTS

There are various resources available in researching vendors and integration services for RFID products. The method and sources used for this work began with reviewing previous RFID thesis to discover what relevant research literature existed on RFID applications for item-level management. This effort provided an excellent list of online resources and literature to weed through, specifically several sources for identifying case studies. With the list of references in hand, it was easy to find case studies that described similar organization that successfully implemented RFID systems as replacement to manual/bottleneck operations.

1. Studies

Although there are many online sources that provide case studies, some of them require a paid subscription to access the full report. Even so, a significant amount of information could be gleaned from abstracts provided on the website. Oftentimes, points of contact identified in the organization discussed in the case study provided more details if contacted by phone/in person. This method may prove to be very fruitful to organization in their early stages of requirements discovery for their mapped business process. There are trade studies (at a premium ranging from \$500 to \$3000) that cover a variety of important topics such as hardware testing; end-user rating of vendors/providers; forecast analysis of RFID technology application and evolution by highly acclaimed analyst groups (e.g. Gartner Group) who are respected in industry for their consistent foresight; etc.

While searching and reviewing cases studies online, the research branched off to trade shows/conferences. There are several to choose from depending ones travel budget. All trade conferences hosted during the period of this research claimed to be the biggest “must attend” event for RFID. It is fortunate that EPCglobal U.S. was hosting its annual conference during this period. EPCglobal US is the U.S. component for the RFID and electronic product code (EPC) standards body, EPCglobal Inc. EPCglobal US is responsible for promoting the specifications in standards set forth by their parent standard body.

2. Conferences/Trade Shows

The conference brought together RFID industry leaders in both the supplier and consumer markets. Opportunities were abound for networking and collecting information on what to consider when investigating in RFID options. By far, conference trade shows are one of the premier sources for a fact-finding mission given that the researcher is fundamentally familiar with the subject being investigated. The volume of information at these conferences can be overwhelming as vendors and service providers are eager to capture the attendee’s undivided attention. If the conference offer workshops along with a trade show, this is best balance in getting value from attending these conference/trade shows. This is because it presents the opportune time to collect information about options under consideration. End-users who have been at the level of implementation maturity (Figure 15) faced by other organization attend these conferences and are willing to discuss their lessons learned. Attending the trade show portion of the conference allows the attendee to do comparisons among vendors to determine which offer options that address the requirements for improving their “As Is” business process.

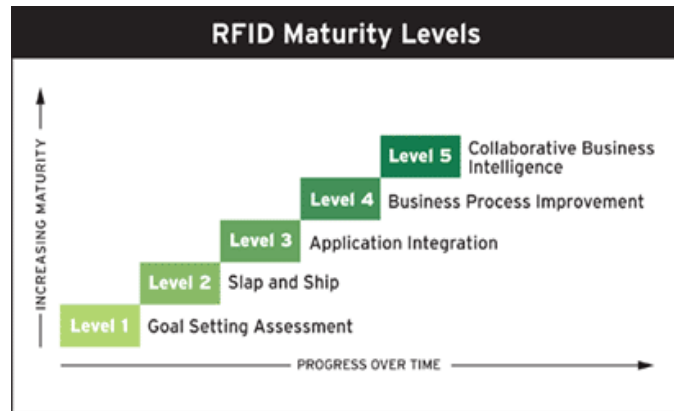

Figure 15. Maturity level in RFID implementation (From: Blossom, 2005)

3. Developing a To-Be Model

An organization can develop a “To-Be” model based on information gathered on how RFID technology works along with examples of industry application. The most simplistic way to determine quality requirements for improving a business process is by identifying bottlenecks in steps of the “As-Is” model. Then creating a profile of scenarios to address how the steps should perform provides insight towards improving the business process. Key stakeholders of the business process must collaborate in capturing the steps as well as developing the scenarios that describe quality requirements. An evaluation method that employs the use of scenarios in identifying quality requirements is discussed in a book written by Paul Clements et al, “*Evaluating Software Architectures: Methods and Case Studies*”.

Although the book addresses evaluations of architectures, these methods offer tools for evaluating business processes as well. Chapter three of the book discusses the Architecture Tradeoff Analysis Method (ATAM), which focuses on the notion of system suitability. The bottom line is that a workflow map serves as the framework in the evaluation process. An evaluation of the framework by key stakeholders can drive the coupling of system functionality with achieving the organization’s business goals. The evaluation process has nine steps:

1. Present the ATAM
2. Present business drivers

3. Present architecture
4. Identify architectural approaches
5. Generate quality attribute utility tree
6. Analyze architectural approaches
7. Brainstorm and prioritize scenarios
8. Analyze architectural approaches
9. Present results

In the steps used to evaluate system suitability (Table 5), some of the step descriptions were modified from the list stated above in order to fit the application for assessing the “To Be” business process. A more detailed use of this evaluation method is explained in “*Evaluating Software Architectures: Methods and Case Studies*” (Clements, Kazman, & Klein, 2002).

The most value occurs in steps five through eight, which results in a collective analysis by key stakeholders and project lead representatives as to system suitability. The definition of suitability in this context means that a “To Be” business process can achieve performance within or above stated functional and quality requirements; at or below cost; and within or less than a scheduled delivery. The beneficial points of this evaluation relates to steps five and seven, the organization captures implicit knowledge by documenting profile scenarios. These scenarios serve as a repository for future evaluations of similar processes in the organization. The basic format of the scenarios has three parts:

1. What the stakeholder does to initiate an **event** with the mapped system,
2. What is going on within the **environment** the system operates at the time the event is initiated, and
3. How the **response** the system should execute based on the initiated event (Clements et al., 2002)

Step	Description	Input	Output
1. Assessment method	Evaluation team lead describes assessment method to participants (stakeholders, project lead, evaluation team, etc)	Assessment method brief	Common knowledge of procedures among assessment participants, facilitates communication between stakeholders by putting them in same room
2. Business case	Project lead present the business drivers that identified capability gap	Business case brief	Explicit project objectives
3. Functional requirements	Project lead describe desired functional requirements and how they relate to capability gap	List of functional requirements	Explicit course of direction toward project objectives
4. Workflow maps	Project lead present workflow map of current and desired business process	Graphic view of logical data flows for current and desired business process	Explicit depiction of current and end-state business process
5. Usage profiles	Sample stakeholder group create a utility tree of quality attributes and usage profiles with sample scenarios that demonstrate impact functional requirements	Sample stakeholder generate ideas of how a system that's functioning as stated in functional requirements is likely to react and should respond based on profiles (usage, safety, maintainability, security, etc)	Utility attribute tree of prioritized measurable scenarios listed quality attribute category
6. Map profiles to functional requirements	Project lead and sample stakeholder group map quality attributes to functional requirements	Step 5 output	Sample impact analysis showing risk, non-risk, trade-offs and sensitivity
7. Prioritization and selection key scenarios	Use larger group of key stakeholder to create and add larger selection of scenarios to sample for in order to prioritize and select the most important scenarios for testing	Key stakeholder representative generate additional ideas of how a system that's functioning as stated in functional requirements is likely to react and should respond based on profiles	Prioritized list of consensus selected scenarios that depict what's required for system to meet in order to succeed
8. Test selected scenarios	Test selected scenarios, results reveal risk, non-risk, sensitivity points, and trade-off points	Step 7 output	Documented impact analysis
9. Results	Use results to conduct impact analysis on business process to identify benefits and system suitability for functional requirements	Step 8 output	Results of assessment indicating system suitability

Table 5. Sample steps to evaluate system suitability

Steps one to four and step nine in the evaluation method provide the administrative support for describing the business drivers, the model and results for the assessment framework.

4. Software Simulation

Once the following information and artifacts are documented and analyzed, a simulation of the “To Be” workflow would provide an indication of how the recommended options would function.

- Map “As Is” workflow
- Familiarization and fact-finding about technology under consideration (especially with regard to the existence of current standards);
- Results of analysis assessments for options under consideration
- Map “To Be” model based on functional and quality requirements

The next step involves development/solicitation of a simulation for the “To Be” workflow model. Several RFID integration providers exist in the market that have lab services can produce a model and simulation of user requirements. Given that an initial investment can be quite costly, a simulation model would provide the visual context for assessing whether technical feasibility can meet functional requirements. Use cases generated during the evaluation of workflow would serve as good input for conducting simulations.

C. CONDUCT COST BENEFIT ANALYSIS FOR RFID FEASIBILITY

Benefits and risk in considering RFID implementation are captured during the assessment of the “To Be” workflow model. The results from this process provides the information necessary for looking at the cost associated with these risks and benefits when requesting information from vendors. Using documented functional and quality requirements along with results from a simulation will assist an organization in drafting a request for information document. There are several (rfd.technologyevaluation.com, epcglobal.org, rfidsb.com, rfidupdate.com, etc) websites that advertise matching

consumer to vendor/provider for RFID implementation. Some offer templates (Figure 16) for submitting the details for requirements. Using templates can bridge the gap in conveying user requirements with common terms that are familiar to vendors.

Technology Evaluation Centers Inc. Radio Frequency Identification (RFID)		Functional and Technical Worksheet										TechnologyEvaluation.Com The Impartial Software Evaluator
Hierarchy	Criteria	Priority (0-10)	Mandatory (Y/N)	SUP	MOD	3RD	CST	FUT	NS	Comment		
1 Tags and Data Storage Devices												
1.1 Tags												
1.1.1	Class 0—passive (read-only and factory programmable)										Generally used for electronic article surveillance (EAS) tags, retail, baggage, etc.	
1.1.2	Class 1—passive (read and write once)										Commissioned in facility.	
1.1.3	Class 1—generation 2										A class 1 standard proscribed by ePC called the UHF Generation 2 Air Interface Protocol.	
1.1.4	Class 2 (read and write)											
1.1.5	Class 3—adds power supply to passive tag										Portable data capture for manufacturing, production, or transportation.	
4.2	Use of open tools and architectures											
4.3	Delivery layer allows role-based design, data access, and semantics											
4.4	Delivery protocols with a GUI approach											
4.5	Web server layer											
4.6	Data source adapter and integration techniques											
4.7	Web integration services											
4.8	Role-based workflow management											
4.9	Notification protocols with devices supported											
4.1	Mapping and remapping techniques											
4.11	Customer install solution delivery											
4.12	Hosted solution delivery											
4.13	Traditional security for users and hierarchy support											
4.14	Security accross trading partner network											
4.15	Access to validate shipping and brand information											
4.16	Carrier networks (GSP)											
5 Middleware											Middleware adds RFID-specific capabilities to allow RFID-type information to be analyzed and then transmitted to business applications. It can function in two levels—reader to middleware and edger server to application.	
5.1 Capabilities												
5.1.1	Data capture and translation											
5.1.2	Filter, clean, and validate information											
5.1.3	Associate and create, append transaction to add information to prepare data to transmit to business											

Figure 16. Sample of RFI template (From TEC, 2004)

Vendors selected from responds to request for information would relate to those who best match the stated functional and quality requirements. The vendors selected would typically be the same vendors used when requesting proposal for acquisition and installation cost. The responses from the request for proposal are used to evaluate the feasibility of implementing an IT solution based on the “To Be” KVA analysis, i.e. selecting the vendor that offers the best ROI/ROK.

THIS PAGE INTENTIONALLY LEFT BLANK

IV. STRATEGY DEMONSTRATION

The strategy described in this thesis demonstrates a mock licensing motor vehicle organization (LMVO); here after refer to as the LMVO. The LMVO is located in a U.S. city with a population large enough to require three service center facilities operating in three different major business areas. Over the last six months, the Chief Technology Officer (CTO) for the LMVO has followed media news, journals and whitepapers about the capabilities of RFID technology. She has decided that the time is right (class-1 Gen2 standards) for investigating RFID as an item-level tracking option for improving the organization's reference material management service (RMMS). The CTO has considered several options (bar codes and digital conversion of records) for addressing the excessive use of person-hours spent on manual item tracking processes such as:

- Looking for misplaced items,
- Customers waiting for clerks to check items out/in
- Conducting item inventory

About five years ago, the CTO conducted a pilot bar code project. The results show minimal return on investment (ROI) when compared to reducing person-hours spent conducting inventory and zero impact on efforts spent locating misplaced items. The CTO believes that leveraging RFID capabilities can virtually eliminate the two shortfalls that are inherent in a bar code capability. The LMVO organization chart below (Figure 17) shows the hierarchy of organization structure.

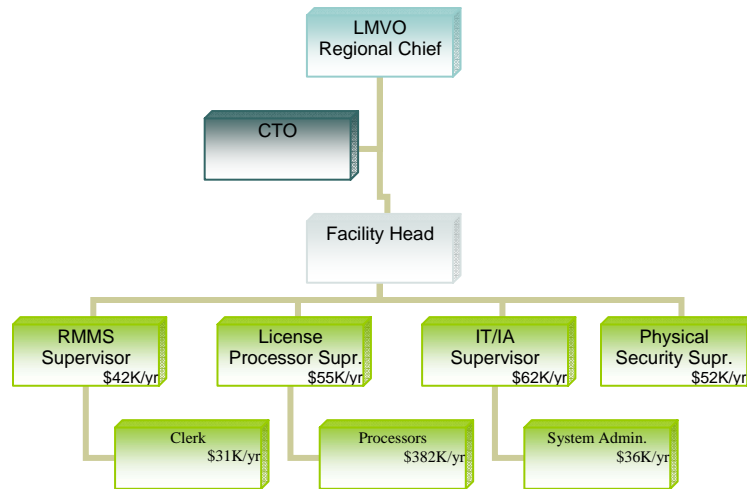

Figure 17. LMVO organization chart

The following is the structure of the LMVO:

- Each facility operates in a one level building
 - ✓ Facility one maintains 25K records of reference material, some records have bar codes which are not used, 3 clerks manage RMMS for customer base of 120 employees, open 8 hours/day
 - ✓ Facility two maintains 6K records of reference material using bar codes, 1 clerk manage RMMS for customer base of 10 employees, open 4 hours/day
 - ✓ Facility three maintains 20 controlled portable IT devices using barcodes and 18K records of reference material, some records have bar codes but not used, 2 clerks manage RMMS for customer base of 80 employees, open 8 hours/day
- All facilities use PeopleSoft enterprise resource planning (ERP) database interface to manage checkout and check-in accountability of

records and controlled information technology (IT) assets, databases are distributed

- Each facility has a central records/item location (RMMS office) that provides customer service for checkout and check-in use of controlled items
- RMMS offices that don't use bar codes require manual entry of item unique id number into ERP for item checkout /check-in, bar code replacement every six to eight months
- All RMMS offices must manually enter customer unique id number into ERP for item checkout /check-in

A. STAKEHOLDERS

1. IT and Information Assurance Division

The IT division at each facility believes the requirement for investigating radio frequency identification (RFID) extends from the customer dissatisfaction in RMMS offices business process. Their concern for RFID relates to the impact on information security and interoperability when integrating new technology/systems. With regard to information security, they have voiced concerns about data being captured by unauthorized personnel. This issue relates to the distance the harmonics of a RF wave can travel from its source i.e. RFID devices generating RF signals. As for interoperability, their concern focuses on configuration that may require changes in order to interface with the ERP database in light of existing plans to migrate the ERP to an Oracle platform. The IT division needs to maintain the integrity and structure of the existing database in order to implement the ERP migration scheduled to occur over the next 18 months.

2. Internal Customers

Customers License Processors (LP) represents the internal customers in the LMVO organization. They perform periodic review of client records to determine status of driving privileges. License Processors also conduct road tests with clients when necessary. At facility three, Processors use portable global position system navigation to map the route they direct clients to drive during a road test.

Processors use the ERP to identify clients whose records they need to review and then generate an email (via another application other than the ERP) to the RMMS office requesting the record(s). The Processor will receive an email reply to pick-up the record(s) once they have been retrieved from the RMMS office records/item storage room. Since a request does not always result in pick-up, the policy from the RMMS office supervisor instructs the clerks begin the checkout process once the Processor presents their employee identification. The checkout process can take from five to 10 minutes per item for offices that do not use bar codes; four-9 minutes for those using bar codes.

3. RMMS Office

The supervisor in each of the RMMS office often tasked with trying to provide customer satisfaction on a limited budget, with limited labor, and having to use a manual process where the number of accountable items is increasing. The business process statistics (Table 6) table shows information for item active by each facility:

Activity	Facility 1	Facility 2	Facility 3
Item growth rate/year	1%	15%	2.8%
Item checkout s /day	77	18	55
Item check-ins/day	50	12	36

Table 6. Example of business process statistics

The clerks would welcome some relief in automating their customer service process and item management, especially with regard to conducting inventory. The major concern by this group relates to the learning curve required with a RFID implementation. Most personnel within LMVO become proficient at using the ERP within two months. It takes a clerk about two weeks of on-the-job-training (OJT) to become proficient at item processing and inventory management. A RMMC office supervisor attends a two-week formal training course and four months OJT to become proficient at running the RMMC office.

4. External Customers

The Processors responsibilities require a timely review of records associated with their assigned external customers, motorist. A delay in review could result in an external customer not receiving their required services such as notification to renew a license or imposed restrictions due to adverse information from motorist information agencies. Delays for the Processors often related to lost or missing records. Although external customers are not direct users of RMMS, they are impacted by its operations.

B. BUSINESS CONTEXT/DRIVERS

The CTO selected the team members based on group dynamics that exist within the LVMO organization. Several employees have a long work history in the organization and as a result rely on stability in the way processes function (Mintzberg, 1981). This in turn leads to the possibility that a buy-in to change, regardless to how effective, could meet with resistance by some employees. The basis of her concerns about resistance relates to an article she read from the Harvard Business School on “*Leading Change*” which presented a formula on the impact of change. The formula states: Amount of Change = (Dissatisfaction (D) x Process (P) x Model (M)) > Cost of Change (CC). In other words, the amount of change required must have a cost of change less than the product of:

- Dissatisfaction in the current state (“As Is” process)
- A model (vision) of a future state (“To Be” process) and the behaviors, attitudes, structure and system required for attain the model
- Processes of many sequenced events aimed at helping individuals learn new skills, attitudes and behaviors (Beer, 1988).

The formula merely provides a point of reference for considering factors that interact with each other in an organization, i.e. cause and affect. The formula does not represent a purely nominal value but more along the lines of benefits gained over those losses when implementing change. Therefore, the benefits of change need to exceed the losses that change is likely to bring about. An example of loss relates to stalled realized returns from a change implementation due to resistance. When personnel fear the loss of their job, positional authority, or other workforce benefits brought on by change their resistance, subtle or otherwise, could slow the transition of the change effort.

The plan to mitigate resistance required the CTO to get maximum buy-in from key stakeholders, i.e. create a positive perception (Jick & Peiperl, 2003). This would entail getting them involved with the vision of improving the item-level management process. Thus, the CTO conducted a two-day off-site retreat with all office supervisors from each facility to brief the latest item-level management exception reports. Then discussed the current applications of RFID in organizations similar LMVO and requested each supervisor recommend one person from IT, RMMS and LP to participate. She explained that the recommended personnel would make up a team of key stakeholder representatives that will investigate leveraging RFID options to develop recommendations for resolving the repeated issues identified in the item-level management exception reports.

Having a team of key stakeholder representatives sets the initial point in creating a positive perception about RFID. While the team is on its fact-finding mission, the CTO focused on the rest of the organization for creating a positive perception through education and communication. This effort helps to minimize the effects of negative re-

enforcing patterns/behavior such as rumor-mills due to lack of feedback and misinformation from outdated material. Using information from documented business cases on successful RFID implementation provides an avenue for initiating a publicity campaign to emphasize the necessity and benefits of a vision statement “Faster item access through automated item-level visibility”.

A measure for really drawing attention to the information campaign could offer incentives such as cash awards. The CTO could solicit LMVO personnel to submit RFID use cases, if selected by the project the person would receive the cash award. Other types of rewards (citations, compensation day, etc) might appeal to personnel not enamored with cash incentives. The intent with this approach is two-fold, to get the correct information disseminated and expose personnel to the desire of using RFID technology.

The CTO selected a senior License Processor to head up the research/evaluation team to discover the latest RFID technology. The selected Processor was involved with the bar code pilot and thus eager to research a more efficient means for improving item-level visibility. The CTO explained the business drivers that the research/evaluation project needed to satisfy the following requirements:

- FR1 - Reduce turn-around time of item checkout /check-in to enhance customer responsiveness
- FR2 - Provide more accurate visibility/accountability of items within LMVO
- FR3 - Significantly reduce the number hours personnel spent in inventorying items
- FR4 - Reduce data errors in the ERP data base by eliminating manual data key entry
- FR5 - Increase overall efficiency of RMMS business process with a AIDC capability

She also identified the constraints on the business process as:

- C1 - Limited IT budget

- C2 - Learning curve for operators and maintainers
- C3 - Disruption to operations during implementation
- C4 - Limited IT personnel resources
- C5 - Stability in product standards

The final guidance the CTO provided the team lead was the necessity of measurable qualities for a proposed RFID system. She related that in her preliminary survey of available products available revealed various vendors whose services/products appear to offer the ideal solution. Therefore, to ensure that nearly all factors taken into consideration the following quality requirements recommended:

- QR1 - Interoperability with the existing infrastructure
- QR2 - Demonstrate high performance levels
- QR3 - Robust security features
- QR4 - Easy integration with future upgrades/technology

C. ANALYZING WORKFLOW PROCESS

With documented guidance on business drivers and constraints, functional and quality requirements, the project lead scheduled a meeting with the team. The chief technical officer (CTO) was invited to the initial meeting and attended so she could field any questions the team needed clarity as laid out by the team lead's presentation of the project's purpose. After all questions regarding the project purpose and guidelines were addressed, the team lead went on to present the strategy that would be employed to accomplish the project objective; research and assess RFID options that can meet stated functional and quality requirements based on given constraints. The strategy entails:

- Analyze workflow processes using KVA analysis
- Research RFID technology that meet requirements

- Conduct a cost/benefits analysis

The team’s administrative support recorded information developed during project work sessions. The team began their task by mapping out the current workflow of the RMMS item-level management process. The team used the collaborative tool application to brainstorm the steps involved in the process. The tool was quite useful in several applications through out the project. Especially when used with WebEx Connect, software-as-a-service (SaaS) application, to allow members of a project team to contribute from remote location by using a shared environment via the internet (Webex Communication, Inc, 2007). Using this application and web service allowed the team to produce an “As Is” workflow as seen in the segment of inventory diagram (Figure 18, also shown in Appendices A and B). The overall workflow has many steps, which is way the screen shoot is so small, a segment of the Inventory sub-process is shown to give more detail from the screen shoot.

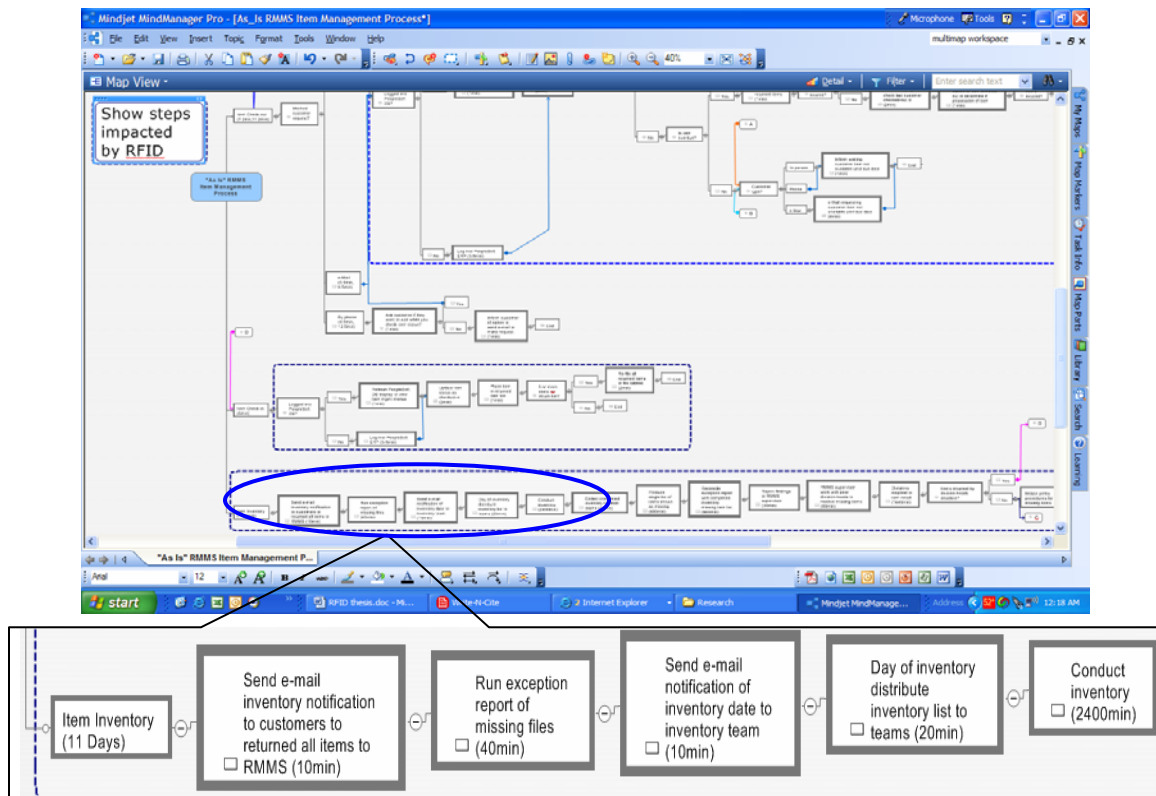

Figure 18. Segment of Inventory sub-process in As-Is RMMS business process

The table showing cycle times (Table 7) reflect the results of mapping the workflow of current operations, “As Is”. The map reveals the actual cycle times for each step in three sub-processes, item checkout, check-in and inventorying, which comprises the overall business process of item-level management by the RMMS office. The LMVO project team only conducted a knowledge value added (KVA) analysis of the inventory and checkout sub-process because the check-in process partially mirrors the checkout process.

Activity	Facility 1	Facility 2	Facility 3
Inventory (I), reconcile (R)	40 hrs (I) 48 hrs (R)	10 hrs (I) 12 hrs (R)	29 hrs (I) 13 hrs (R)
Avg. checkout time	7.2 minutes	1.7 minutes	5.1 minutes
Avg. check-in time	6 minutes	1.4 minutes	4.3 minutes

Table 7. Cycle times revealed from “As Is” map workflow

Since the RMMS office functions as a non-profit entity, the team used certain assumptions and industry comparable values to evaluate the amount of knowledge at work in the “As-Is” workflow model. KVA uses revenue for cost valuation in determining return on knowledge (ROK), the ROI from knowledge invested in intellectual and IT capital. Thus, the market comparables revenue for the “As Is” process uses U.S. government published rates for record audit/reviews on personnel security status (U.S. Office of Personnel Management (OPM), 2006). The checkout sub-process uses comparable salaries from online job repositories such as Monster.com, Vault.com and Payscale.com for file clerks working organization that manage record/reference material (Payscale.com, 2007).

In both analyses (inventory and checkout sub-processes), the LMVO RFID project team had to assess the actual learning time (ALT) required for an average clerk or auditor to become proficient in managing and using the RMMS office, respectively. The learning time involved training under instruction and OJT on how to use the PeopleSoft ERP application for item management and COTS applications. ALT information derived from supervisor representatives in the teams; they have thorough knowledge of how

information flows within LMVO. Clerk representatives on the team derived a nominal assessment of steps for each sub-process since they are the vehicles, in a sense, that make the information flow.

KVA quantify nominal assessments by having a representative with detailed knowledge about the sub-process assign a notional 100 units of knowledge to each step in a sub-process in proportion to the level of difficulty associated with the step. The correlations of using nominal and ATL as reflected in the “As Is” checkout and inventory sub-processes (Figures 19 and 20, also shown in Appendices C and F) resulted in 88% and 86%, respectively. Performing this comparison provides a check and balance of how

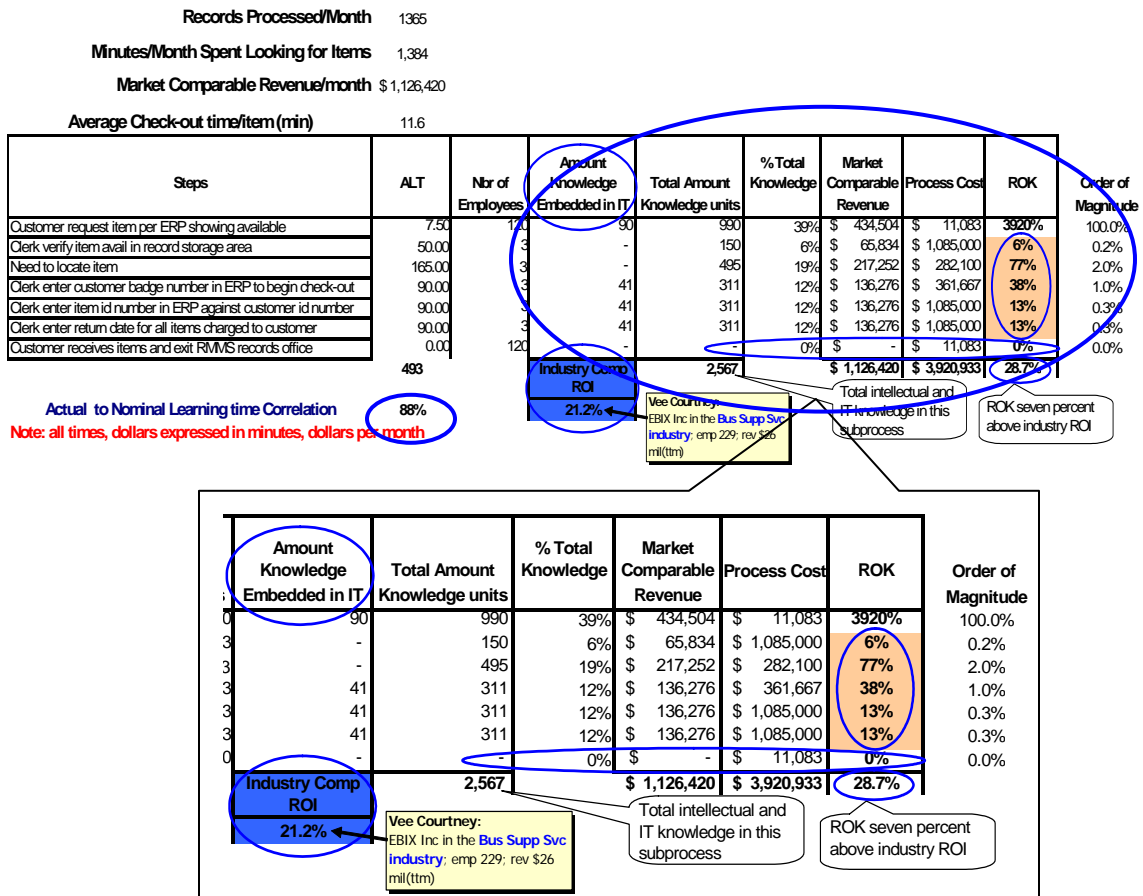

Figure 19. KVA results of the As-Is item checkout sub-process

Inventory Completion Time 5280

Industry Revenue/hour\$ 16 Total/month \$ 1,689,600

Steps	ALT	Nbr of Employees	Amount Knowledge IT	Total Amount Knowledge units	% Total Knowledge	Market Comparable Revenue	Process Cost	ROK	Order of Magnitude
Clerks send LMVO inventory notification	15.00	3	5	50	1.12%	\$ 18,877	\$ 1,590	1187%	0.92%
Clerks run exception report of missing items	90.00	3	41	311	7.01%	\$ 118,411	\$ 3,179	3724%	2.88%
Clerks send inventory team notification	15.00	3	5	50	1.12%	\$ 18,877	\$ 1,590	1187%	0.92%
Clerk provide teams their list of items	1.50	3	0	5	0.10%	\$ 1,716	\$ 7,949	22%	0.02%
Two-person team conduct inventory of listed	115.00	20	0	2300	51.91%	\$ 877,120	\$ 3,653,846	24%	0.02%
Two-person team produces soft copy of inventoried/missing items	45.00	20	90	990	22.35%	\$ 377,543	\$ 292	129159%	100.00%
Clerks merge inventoried/missing item lists	115.00	3	35	380	8.57%	\$ 144,725	\$ 795	18207%	14.10%
Clerks reconcile exception and inventoried missing reports	90.00	3	27	297	6.70%	\$ 113,263	\$ 2,385	4750%	3.68%
Clerk report findings to RMMS supervisor	12.50	3	0	38	0.85%	\$ 14,301	\$ 795	1799%	1.39%
RMMS supervisor brief peer division heads on missing items	12.50	1	0	13	0.28%	\$ 4,767	\$ 3,231	148%	0.11%
				4,431		\$ 1,689,600	\$ 3,675,651	46%	

Actual to Nominal Learning time Correlation 86%
 Note: all value expressed per month

Industry Comp ROI 26.2%
 Vee Courtney: Health Grade Inc in Staffing & Outsourcing Industry: emp 106; rev \$26 mil(11m)
 Costing more to perform than if then an outsource company might charge

Steps	Amount Knowledge IT	Total Amount Knowledge units	% Total Knowledge	Market Comparable Revenue	Process Cost	ROK	Order of Magnitude
3	5	50	1.12%	\$ 18,877	\$ 1,590	1187%	0.92%
3	41	311	7.01%	\$ 118,411	\$ 3,179	3724%	2.88%
3	5	50	1.12%	\$ 18,877	\$ 1,590	1187%	0.92%
3	0	5	0.10%	\$ 1,716	\$ 7,949	22%	0.02%
20	0	2300	51.91%	\$ 877,120	\$ 3,653,846	24%	0.02%
20	90	990	22.35%	\$ 377,543	\$ 292	129159%	100.00%
3	35	380	8.57%	\$ 144,725	\$ 795	18207%	14.10%
3	27	297	6.70%	\$ 113,263	\$ 2,385	4750%	3.68%
3	0	38	0.85%	\$ 14,301	\$ 795	1799%	1.39%
1	0	13	0.28%	\$ 4,767	\$ 3,231	148%	0.11%
		4,431		\$ 1,689,600	\$ 3,675,651	46%	

Industry Comp ROI 26.2%
 Vee Courtney: Health Grade Inc in Staffing & Outsourcing Industry: emp 106; rev \$26 mil(11m)
 Costing more to perform than if then an outsource company might charge

Figure 20. KVA results of the As-Is inventory sub-process

the process works and what inputs are required to produce the outputs within the sub-process. The ALT used in the analyses is shown in the “As Is” inventory and checkout facts (Tables 8 and 10) tables.

Known Facts:		
Documented stastics		
Avg time cycle to conduct inventory(min)		2400
Avg cycle time to reconcile inventory results(min)		1440
Avg cycle time to generate COTS e-mail(min)		10
Avg cycle time to generate standard reports(min)		40
Avg cycle time to gen completed inventory rpts(min)		240
Avg cycle time to brief inventory results(min)		30
Avg cycle time to complete inventory(days)		11
Market Comparable Revenue		
Price/hour	\$	16
Actual Learning Time		Actual LT/month(min)
Generate email		15
Generate custom reports		45
Conduct survey		115
Brief inventory results		12.5
Generate std reports		90
Task Learning Times		LT UI(min) OJT(min)
Generate email		120 60
Generate custom reports		240 300
Conduct survey		480 900
Brief inventory results		150
Generate std reports		480 600

Table 8. As-Is inventory facts

This information affects the revenue side of the ROK equation because when organizations invest in knowledge they are able to produce more output. Therefore, portions of the organization's revenue consist of the percent of knowledge units required to perform that task/step. The other half of the equation relates to cost in producing the output. In these analyses, cost relates to employee salaries and the number of times they must repeat a step in one of the sub-processes, i.e. number of times fired. In essence, an employee is paid to perform their assigned job but a portion of their annual salary can be tied to the number of times they fire a step in a sub-process step during the period (monthly in this case) being analyzed; referred to as the process cost calculation (Table 9) shown in the table below for both sub-processes.

Sub-process Cost Calculation			
Steps	Times Fired/Month	Salary Monthly	Process Cost
Clerk send LMVO inventory notification	0.7	\$2,385	\$ 1,590
Clerk run exception report of missing items	1.3	\$2,385	\$ 3,179
Clerk send inventory team notification	0.7	\$2,385	\$ 1,590
Clerk provide teams their list of items	3	\$2,385	\$ 7,949
Two person team conduct inventory of listed items	1250	\$2,923	\$ 3,653,846
Two person team produce soft copy of inventoried/missing items	0.10	\$2,923	\$ 292
Clerk merge inventoried/missing item lists	0.33	\$2,385	\$ 795
Clerk reconcile exception and inventoried missing reports	1	\$2,385	\$ 2,385
Clerk report findings to RMMS supervisor	0.33	\$2,385	\$ 795
RMMS supervisor brief peer division heads on missing items	1	\$3,231	\$ 3,231
As-Is inventory			
Steps	Times Fired/Month	Salary Monthly	Process Cost
Customer request item per ERP showing available	4	\$ 2,923	\$ 11,083
Clerk verify item avail in record storage area	455	\$ 2,385	\$ 1,085,000
Need to locate item	118	\$ 2,385	\$ 282,100
Clerk enter customer badge number in ERP to begin check-out	152	\$ 2,385	\$ 361,667
Clerk enter item id number in ERP against customer id number	455	\$ 2,385	\$ 1,085,000
Clerk enter return date for all items charged to customer	455	\$ 2,385	\$ 1,085,000
As-Is item check-out			

Table 9. Cost calculations for KVA analysis sub-processes

Information about assumptions and facts (Tables 8 and 10) identify factors that drive cost and revenue in the sub-processes. The KVA analysis (Figure 19) for the “As-Is” item checkout sub-process revealed a ROK seven percent above that of a comparable company in the same industry, Business Services industry (Hoovers Dunn and Brad Street (HD&BS), 2007a). The areas targeted for improvements in the “As Is’ model are those steps with an ROK under 100 percent.

Assumptions:		Known Facts:	
Analysis based on facility one as a baseline for other facilities		Documented statistics	
RMMS Supervisor - \$41K/yr; 4 yrs exp	\$ 42,000	Avg cycle time spent looking for item(min)	3.9
RMMS Clerk – \$26K/yr; 3 yrs exp	\$ 31,000	% Item not in location as indicated in ERP	26%
License Processor – \$38K/yr; 3 yrs exp	\$ 38,000	Avg cycle time to refresh Item mgmnt menu(min)	1
		Avg time cycle for ERP login(min)	2.5
%IT for manual task	0%	Avg time cycle for customer request(min)	2.5
% IT knowledge COTS office applications, i.e. e-mail, etc	10%	Avg cycle time for ERP response to data entered(min)	1.7
% IT knowledge ERP applications, i.e. DB, CRM, etc	15%	Avg number items requested/visit	3
		Avg number request/month	455
Growth rate of records held	1%	Actual Learning Time	Actual LT/month(min)
% Current records standard drivers	72%	Request items	7.5
% Current records commercial drivers	28%	Use ERP item management menus	90
		Search for item location	165
		Verify item available	50
Market Comparable Revenue		Task Learning Times	LT UI(min) OJT(min)
Industry price to create standard record	\$ 2,600	Request items	30 60
Industry price to create commercial record	\$ 3,000	Use ERP item management menus	480 600
Industry price to review standard	\$ 425	Search for item location	480 1500
Industry price to review commercial	\$ 1,800	Check records storage to verify item available	600

Table 10. As-Is item checkout facts

One technique of using the results of a KVA analysis entails comparing the step with the optimal ROK against the other steps in the sub-process/process to determine which steps needs further evaluation if its ROK falls well below 100%. This technique allows the decision maker to review the factors of the optimal step for possible reuse toward improving the other steps. The most optimal step (i.e. the highest ROK) for the “As-Is” checkout sub-processes had a return of 3920%; customers requesting records based on ERP indication of record availability. This step has the largest amount of knowledge units because the number of employees (120 customers) executing the step plus the 10% IT used to generate the request for records, 990 units. The knowledge units are used to determine how much revenue was created by using this knowledge, \$.4M.

The cost associated with this step relates to the salaries paid to process the step. The hourly wage for a License Processor (customer) is approximately \$18 and they typically make four requests per month, which equate to \$.01M in cost, i.e. 3920% ROK. The factors that stand out about the high ROK for this step, the number of knowledge units used and the number of times the step is executed, i.e. number times fired. Given that, one of the constraints for improving the efficiency of the overall process relates to

limited personnel resources, options for increasing the ROK for the other steps points to increasing knowledge or reducing the number of times the step is executed.

This “As Is” model only has three clerks with an hourly wage of \$16 processing request for 120 customers. The clerks process about 1300 request per month thus steps executed by them are fired far more than by License Processors and comparatively they have less knowledge units. Therefore, when comparing steps within a sub-process against the step with the optimal ROK, it may have an order of magnitude that really emphasizes a significant return comparative to other steps in the sub-process. The last in step in the item checkout KVA analysis (Figure 19) showing zero percent ROK is a terminating step, it only requires the customer to leave the records holding area once their request has been completed/addressed, no appreciable knowledge associated with this step.

The last sub-process evaluated was the “As-Is” inventory sub-process. Since this sub-process is executed once per year, cost and revenue are broken down to reflect a one month cost structure. The KVA analysis for the “As-Is” inventory sub-process showed a large disparity in revenue to cost for personnel actually counting the records on-hand; step five - \$.877M revenue to \$3.65M process cost. Even with this disparity, the overall ROK for the inventory sub-process was 20% above the industry average for Information and Records Management services. The industry comparable revenue was an industry standard price per hour for performing/maintaining an Information and Records Management Service (HD&BS, 2007b). The results of the inventory KVA analysis (Figure 21) show the ROK for each step in this sub-process.

D. RESEARCH

The LMVO RFID project team began another brainstorm session to determine what types of RFID technology were applicable to an organization of their size that has/had a similar list of requirements and constraints identified by the CTO. They decided the best approach to discover relevant information existed in documented case studies and trade studies. The team split into two groups, each taking one of the discovery methods to investigate available information. The team decided one month should be

sufficient to develop a portfolio of information gathered; at which time they would meet again to develop a To-Be model based on their findings.

1. Case Studies

a. Academic Institution

The case studies group identified three organizations with documented information who successfully implemented an RFID solution that resembled the requirements and constraints facing their organization. The first case relates to a RFID implementation by a Sponsored Project Research Department at Florida State University (FSU) (3M, 2005). The department is responsible for managing 5K records that contain research project documents with a yearly record growth rate of 3% and a customer base of 40 personnel. The phone interview with the FSU RFID project lead, Ms. Judy Hefren, revealed many similarities between this case study and the thesis mock organization (Judy Hefren, personal communication, January 4, 2007). The similarities paralleled in what requirements and constraints existed in managing a manual records tracking system.

The primary problem faced by the department centered on the amount of time spent each day in locating records, approximately two hours. Customers would checkout records from a central holding office using a checkout card; occasionally the record may end up in the possession of another customer. Oftentimes customers, staff workers managing accounts for sponsored research, must collaborate on staff work, which involved using several records. This in turn results in records being checked out to one staff worker but in the possession of another staff worker. If other staff workers require those same records, the records management office would have to spend time manually tracking down the location of the record.

When asked about the time required to conduct inventory of records holding, Ms. Hefren related they were not able to complete a full inventory prior to the RFID implementation. However, after the system installation it now takes approximately

one hour. The team would later infer, for the purposes of gauging benchmarks in completing inventory, that it required more than a working day for this department to complete an inventory.

Ms. Hefren and her team members looked at bar code as an alternative but the desire from upper management was a system that was more like a RTLS. The constraints for a solution were low cost, ease in management, and no data flow into the ERP (PeopleSoft) database. Bar coding would address the cost but it would not provide a near-RTLS and you could only scan one item at a time vice several with a RFID solution so the team decided on using a RFID solution.

In using a RFID solution, the team considered using active tags for RTLS but decided against this type of tag because at the time of this project, 2004, the price per tag was too costly and shelf life required replacement every 18 months. The team met with 3M consultant and presented their constraints and requirements. The solution developed by 3M entailed using a passive UHF system with tags on the records, Desk Pad Trackers (RFID reader integrated into pad resembling a mouse pad), hand-held readers and three (Locator, Pad Monitor, and Administrative) software packages. 3M provided a brief to the team outlining the system capabilities; the team tweaked this brief to present a business justification for RFID implementation to upper management.

The Locator application provides a near-RTLS by allowing all users to view the status of the record from their desktop and absolve themselves of records possession by updating the record status if they hand the record over to another user. The application interfaces with the RFID database, which is not writing data into the ERP database. Instead, the installation established a server running a Microsoft Access® database that imports queried data from the ERP database. This ensures the integrity of the ERP database and provides records visibility to all users. The Pad Monitor application only runs on workstations that have the Desk Pad Tracker which are used in high record-traffic area, i.e. the central records holding area. This way user can checkout multiple records at one time.

The system maintainer for performing required tasks in managing the RFID database uses the Admin application. Ms. Hefren related that the department has one technician who provides their IT support. The installation did not require any additional training for their technician other than the 3M assistance in building the RFID system interface during one day of the three-day installation process. Their technician does not have specialized background in database skills but has been more than able in managing the low administrative requirements of their RFID system.

The results of the implementation provided customer satisfaction in records visibility, virtual elimination of time expended with personnel looking for records and a short payback period. The system cost approximately \$20K with payback within a year. At the time of installation, the system had a yearly maintenance cost of \$2K for tag purchases required to label the 3% record growth. This cost is likely to be much less, as the price of passive tags, as of this writing, is less than \$1.33 per tag. The system also provided desk pad trackers that can read tags through folders stacked up to 5 inches in thickness and the hand-held readers have a read range of 8 inches. The lessons learned from the implementation were to ensure that tags are staggered in the designated placement location for each folder and that the placement location should be based on how the records are shelved. In this case study the tags were staggered near the bottom inside section of the multi-section folders because the records were shelved landscape. This placement ensured that the tags would be the shelf edge for close proximity for during scans by the hand-held readers.

b. Law Firm

The next case (3M, 2006) relates to the law firm of Fish and Richardson (FR) and how they tackled similar issues addressed in the first case. The point of contact, Gildardo Vargas, was a member of the team that identified requirements and measures for launching a pilot at the firm's first RFID implementation in Boston, MA. (Gildardo Vargas, personal communication, January 4, 2007). Much like FSU, several personnel resource hours were being expended in locating files within the office workspace. The

offices spaces in this case study consisted of a multi-floor office building. A clerk would spend a significant part of their workday, about 3.5 hours, filling out checkout cards or tracking down missing records. High priority request for record would initiate a process to locate a record. Missing records cause delays of work for the lawyers, which could result in a loss in the firm's billable hours.

The checkout card often did not show the correct location of a record. No bar codes used prior to trying RFID. Customers sent e-mails to reference clerks to request records. When the customer retrieve the record from the holding office a clerk filled out a checkout card to charge the record to the customer. Average checkout time for customers to complete a transaction was 10 to 15 minutes.

The firm decided to consider a RFID solution to enhance the operations of records management. The results increased cost savings by reducing the cycle time of personnel time used for manually tracking down records. It also increased productivity of lawyers who no longer had work delays in waiting for records to be located. The strategic benefits from a RFID solution relate to:

- Visibility of intellectual property
- Internal customer satisfaction,
- Improved job satisfaction among file clerks

Although Mr. Vargas did not discuss specific cost for system implementation, he did relate that the initial pilot included 1.2K records using a 3M solution. The results of the pilot proved so successful that the Boston office completely implemented a full RFID system in 2004. The system installed used pad trackers in high record-traffic office areas, hand-held readers for scans during inventory in the central record holding room and throughout the building, and the three software packages 3M uses with their RFID file tracking solution.

Because the Boston implementation proved so effective in improving the efficiency of the business process, the remaining nine FR office locations implemented

the same system setup over the course of three years. Each location varies in the number of records held; the San Diego office has 25K records. During a scan with the hand-held reader in one of the main records holding rooms at the San Diego location, it took approximately 1.2 seconds per record. The average payback for each install was about two months based on the cost of looking for records.

Mr. Vargas is currently the system manager located in the San Diego office for FR distributed RFID systems. The distributed systems allow offices to share status of inter-office/location record loan with a single update vice having the two locations involved in the record loan both updating their own systems. To ensure security of information Vans and firewalls are used at connection points between the distributed systems thus a closed system to maintain system integrity from unauthorized access. He related that for the way their systems are setup, a new user of the system requires about one hour of training. To train a new technician to provide support at one of the office location requires about one month training.

Moreover, although the offices use an ERP tool (ProLaw) specific to law firms, the RFID system uses a separate server connected to the network with an Access database and installed with the three 3M software packages for managing the readers and Locator application. He also noted that no instances of interference from WiFi LANs, cell phones or other forms of EMI to or from the RFID systems have been experienced. The lesson learned was ask the companies under consideration if they have beta pricing, if so at what quantity does it end. This was an important issue for cost drivers such as tags and software licensing.

c. Circuit Court

The last case relates to a judicial circuit court division in Prince Georges County in the state of Maryland. The LMVO team was unable to speak with individual involved in the implementation project for the court. However, they did glean some useful information from the case study. For example, the case study reveal the court also suffered work delays due to missing case files that had to be tracked down by court

clerks. The case-file management division has about 40K cases they must track per year. The courthouse has several offices and judge chamber on different floors that these case-files are passed between individuals.

Again, the current method for tracking files did not accurately provide the correct location of a case-file. In November 2006, the court planned to have a completed an implementation of an UHF RFID system to overcome the extensive use of personnel time spent looking for missing records. The company that provided the system for the implementation was File Trail. The system was also a passive UHF system that not only included hand-held readers and desk/pad type trackers but also fixed zone trackers. According to the case study the zone trackers "...which act as RFID portals, are installed one on each side of a doorway. They capture data about the file as it enters a room, thereby making it possible to track files... not necessarily stacked near a DeskTracker." (Swedberg, 2006). The system expected to cost about:

- \$250K for hardware
- Use 100K tags at .32¢ apiece
- Run on server installed with Windows 2000 server
- Manage tag data with a SQL 2000 database

2. Trade Studies and Conferences

The second part of the LMVO group reviewed research from two trade studies and had a team representative attend the 2006 EPCglobal US conference in Los Angeles, CA. The following information was presented to the group:

a. RFID Analysis from RAND Corporation Global Technology Revolution 2020... Research Report

- "Sectoral Impact: The capability to tag, identify, and characterize commercial products throughout the supply chain will allow manufacturers, distributors, and retailers to control their inventory... and increase efficiency... The principal influence... economic development of

the retail sector through improved inventory control and more efficient marketing.

- *Technical Feasibility:* ...labeling many different products to aid functions such as making purchases at a store, confirming inventory...as well as for use in employee ID cards. These tags label a product or person with a specific code and transmit its information a short distance away (from 1 to 10 meters, but possibly farther).
- *Implementation Feasibility:* The key issue affecting implementation is whether the technology will evolve to address privacy concerns sufficiently enough to enable widespread adoption. ... Several methods have been suggested to protect the privacy of consumers.
- *Diffusion Foresight:* ...commercial globalization demands and current trends, logistics tracking of products will likely be implemented globally.” (Silberglitt, Antón, Howell, & Wong, 2006)

b. Aberdeen Group Finding on Manufacturing Industry RFID Perception and Use

The Aberdeen Group interviewed over 150 manufacturing companies over a six-month period regarding their use and perception of RFID application. The results of the study are as follows:

- Purpose for implementation - primary **objective for implementing RFID** – highest rated response **Asset tracking**, second production efficiency.
- Choice of architecture - for organizations whose **primary objective** was **supply management** with requirements to work in a confined enterprise i.e. **no trade partners** using an ERP **choose a closed loop architecture and passive tag implementation.**

- Key cost concern - data integration as oppose to tags or readers. The respondents needed the ability to not only have visibility of items but also be able use the data being collected in the tag database in actionable ways for making intelligent business decisions.
- Vendor selection – 78% of the respondents agreed that using a vendor who has strong strategic partners and proven success with a customer with a similar organization structure and requirements as the organization that considering an implementation is the best strategy for vendor selection.
- Key Performance Indicator – manufacturers how implemented a RFID solution out performed non-implementers in improvements in process cycle times by 13%.
- RFID impact on types of workflow – process oriented manufacturers are far more effective at using RFID to track people and mobile assets then a discrete oriented process which more effective in using RFID on tracking production management and finished goods.
- Types of tags used – currently more passive than active but more manufacturers plan to use active in future RFID implementation.
- Recommendation for new RFID implementers – choose vendors based on best practices of best in class, get management involved in strategy planning, and use ones organization data concerning areas for improving efficiencies as a guide to planning a strategy. (Klein, 2007)

c. Trade Conference

The representative that attended the 2006 EPCglobal US conference gathered information about how standards for EPC and RFID are generated, reviewed, voted on by consensus and ratified by standards working groups. The conference offer several workshops the first day of the three-day conference where speakers from end-user industry (Dow Chemical, Wal-Mart, Federal Express, etc) shared their implementation

trails and successes. The remaining two days offered interactive (brief followed by questions by the audience) workshops with panelist who were either suppliers under mandate to implement RFID by their customers or research groups (academia and commercial) developing standards-based solutions to RFID issues. After the workshops ended each day a trade show, provide a host of vendors demonstrating their products.

The take always from this event were information pamphlets, journals, e-briefs, and people networking, i.e. exchanging business cards with end-users conducting similar fact-finding initiatives. The representative did receive a follow-up e-mail from the Lowry Computer Products, Inc. and got a chance to discuss RFID middleware purpose and costing. Mr. Bonn, Director of Western Regional Sales, relate the middle/edge ware is required if the tag data is destined for an ERP database. This is because ERP databases cannot process raw data coming from the readers thus the data must be filtered and processed to match the input format of the ERP database. The cost (\$10K to \$150K) for this software is likely to be the most expensive item in a RFID implementation. His recommendation for new implementers is that they need to ask the question “What do I want to do with the information read from the RFID tag?” In answering this question before choosing a solution an organization will ensure the piece of the system will match their objective (Ross Bonn, personal communication, December 8, 2006).

3. To-Be Model

The team used the data gathered to brainstorm on what RFID application would best support a desired “To-Be” workflow model. The team identified four options (Figure 21, also shown in Appendix G) along with their pros and cons then rank them on a scale of one to five (one being the lowest). The tallied values shown to the right of each option indicates the option’s overall ranking for difficulty in integrating with existing infrastructure and importance to the success of system implementation. Although the passive tag option ranked third in importance in success, it clearly has the lowest amount of difficulty in system integration and maintainability.

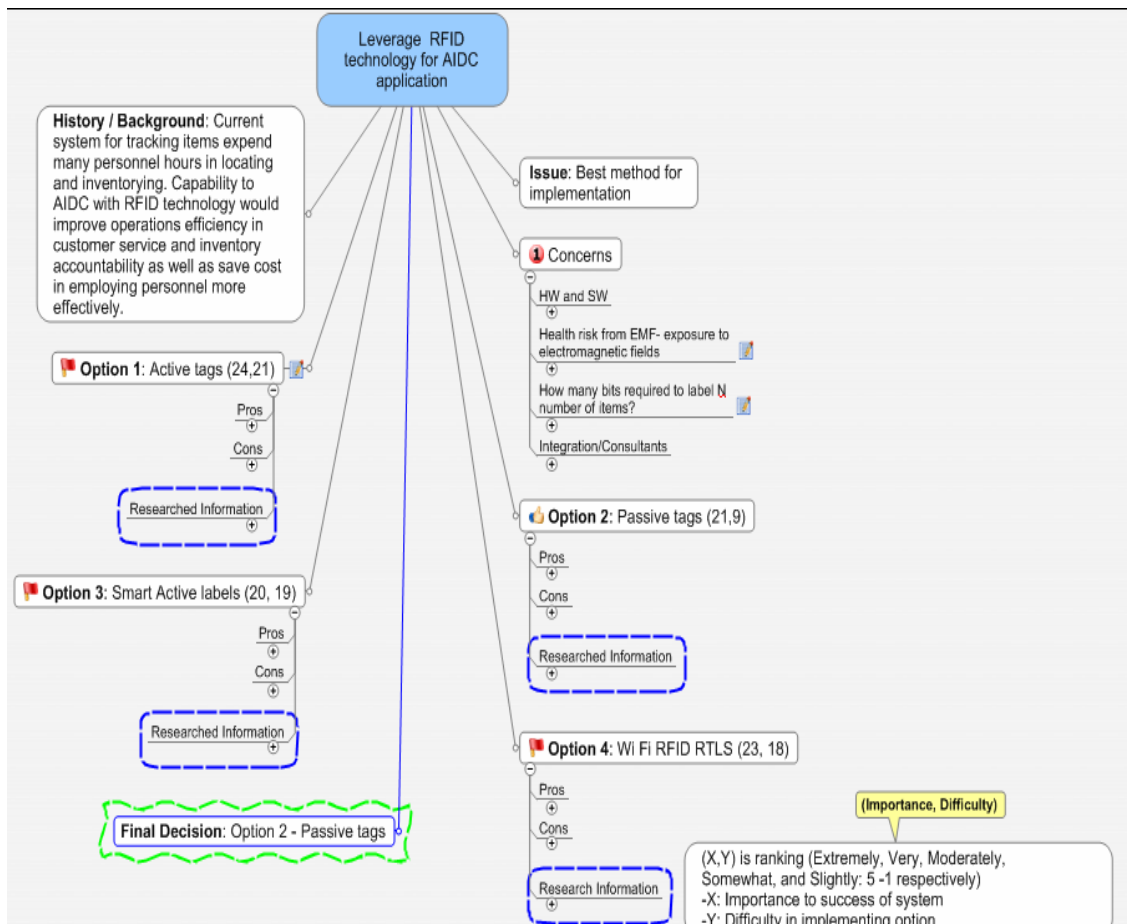

Figure 21. Mind map of brainstorming best method for implementation

Using the knowledge gathered about passive RFID technology, the team identified the areas of the “As-Is” workflow map that would be impacted by RFID (Figure 22, also shown in Appendices D and E). The boxes highlighted in the darker shade of blue are the steps impacted by RFID. In the inventory sub-process some step could be eliminated, bear in mind the “To-Be” model is an estimate of what the team

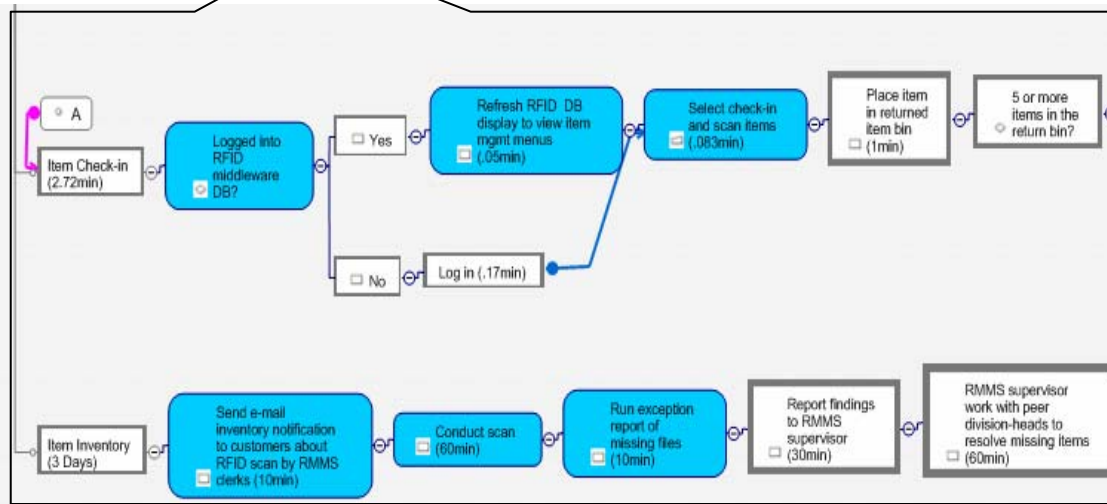
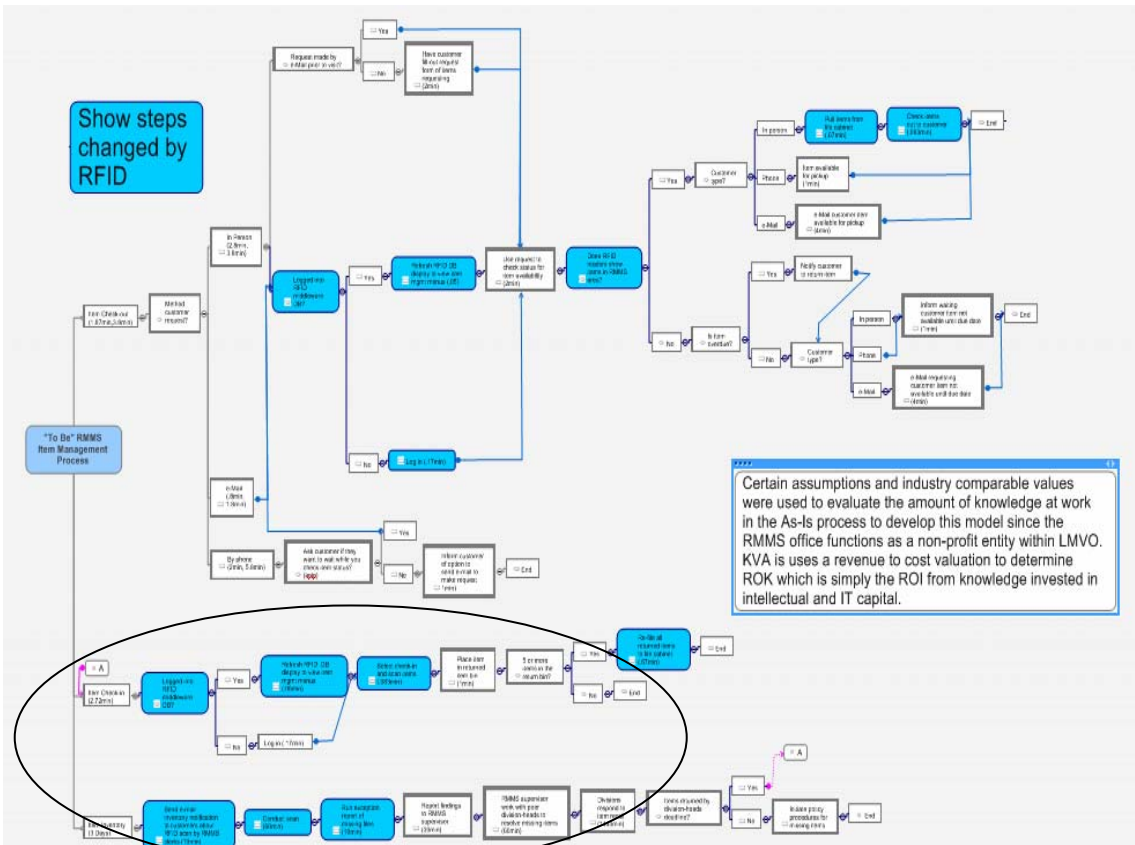

Figure 22. Segment of inventory and checkout sub-processes in the “To-Be” model

anticipate an RFID implementation would do to improve the RMMS office business process. A site survey by the chosen vendor would streamline those capabilities that are most beneficial from a passive RFID system implementation.

a. Risk Assessment

The team used the ATAM evaluation method to assess how the “To-Be” model should respond to the functional requirements identified by the CTO. The quality attributes for evaluating this model are maintainability, performance and security. Figure 23 (also shown in Appendix H) shows the construct of the utility tree and some of the scenarios developed after assessing the To-Be model. The scenarios weighted in accordance with importance to

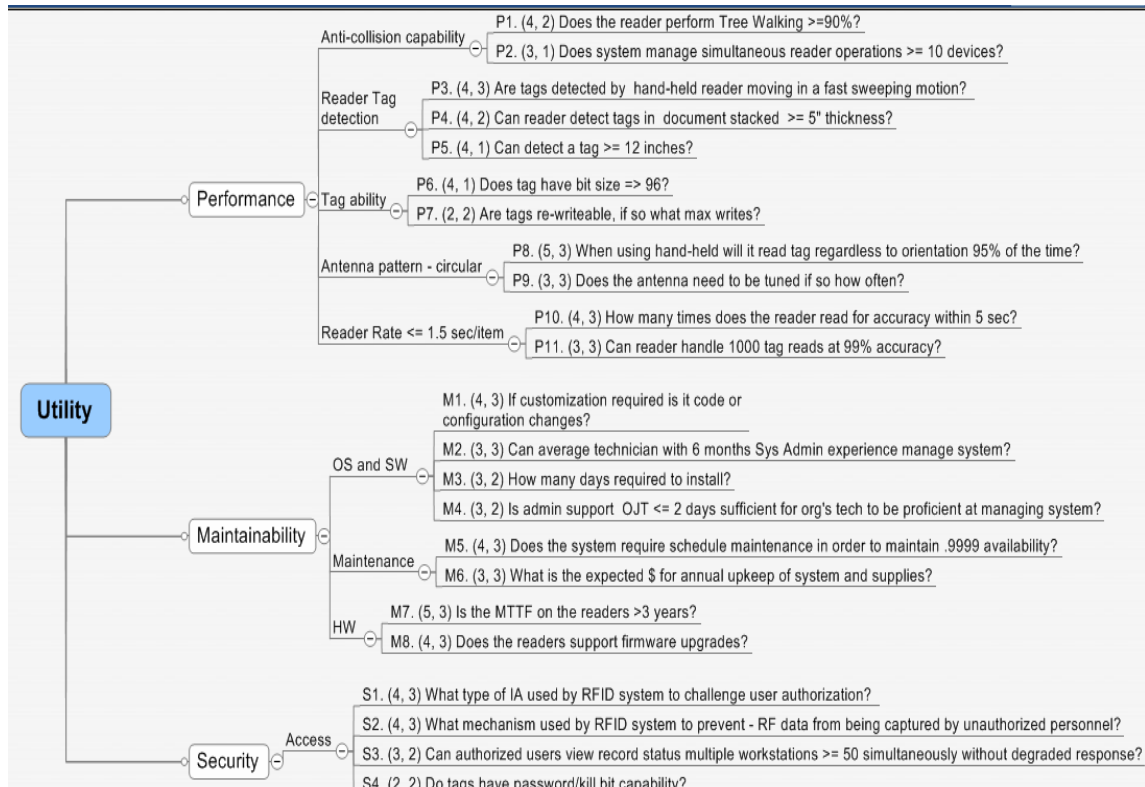

Figure 23. Utility tree and scenarios for To-Be model

success of system and estimated difficulty to achieve implementation. The team prioritized the scenarios with importance of four or higher and difficulty of three or higher (Table 11). The top five most important scenarios were voted on for identifying risk/non-risk, trade-off points and sensitivity points, i.e. a change to one or more steps in the To-Be model affected by a scenario could affect the response value. Trade-off points are the most important because they affect more than one attribute, e.g. installing fixed reader throughout the organization to achieve quasi-RTLS with passive tag would improve performance via increased visibility but the maintainability attributes would be affected with regard to increased technical support skill sets.

Scenario#	Weight	Environment	Stimulus	Response
P3	(4, 3)	Conducting inventory with hand-held	moving in a fast sweeping motion	tags detected 99% of the time
P8	(5, 3)	Conducting inventory with hand-held	multiple tag orientations	read tag 95% of the time
P10	(4, 3)	Any reader	how many reads of single tag to achieve	Accuracy within 5 sec?
M1	(4, 3)	Installation	customization (code or configuration) of software	functional system
M5	(4, 3)	Outage required	for scheduled maintenance	.9999 availability
M7	(5, 3)	Normal	reader failure	MTTF > 3 years
M8	(4, 3)	Maintenance on readers	firmware upgrade	functional system
S1	(4, 3)	Normal	access system	challenge user
S2	(4, 3)	Normal	reader interrogate tag	prevent unauthorized data capture

Table 11. High priority scenarios

The team decided on P3, P8, P10, M7, and S2 as the most important scenarios that will determine if an RFID solution will meet the suitability of stated requirements at the level of quality required to support those requirements. Since the team has already identified which steps are impacted by a RFID solution the next task is to tie the scenario to one or more functional requirements. A review of the requirements and the related scenario is as follows:

FR1 - Reduce turn-around time of item checkout /check-in to enhance customer responsiveness >>> P8, and P10

FR2 - Provide more accurate visibility/accountability of items within LMVO >>> P3, P8, and P10

FR3 - Significantly reduce the number hours personnel spent in inventorying items >>> P3, P8, P10, and M7

FR4 - Reduce data errors in the ERP data base by eliminating manual data key entry >>> P3, P8, and P10

FR5 - Increase overall efficiency of RMMS business process with a AIDC capability >>> P3, P8, P10, M1, and S1

The team reviewed the To-Be map in order to identify the trade-off and sensitivity points, risk and non-risk associated with each FR. Table 12 shows the results of their assessment.

Functional Requirement#	Trade-off	Sensitivity	Risk	Non-risk
FR1		(L, H)S1. Re-shelving with tag far away from storage drawer/shelve edge or stacking records too thick could affect orientation or thickness limit for tag detection (L,M) S2. Incorrect/inconsistent placement of tags on items could result in no read due tag(s) being blocked	(L, H)R1. Unable to reduce cycle time of steps impacted by RFID	(M, M) N1. Assuming reader antenna pattern is circular it is reasonable that staggered tag placement will allow nearly 100% tag detection
FR2		(M, M)S3. Very rapid movement vice careful even sweeps could affect read accuracy (L, M)S4. The number of tags in the read zone and speed of reader passing near tags will impact accuracy of tags read	(L, H)R2. Not achieving level of visibility due to operator ineffective use of system	

Table continued

Functional Requirement#	Trade-off	Sensitivity	Risk	Non-risk
FR3	(M, L)T1. To ensure ongoing operations expect to pay more for readers that are robust enough to withstand incidental dropping by operators in order to reduce MTTF		(M, M)R3. Manufacturer's warranty not providing a loaner if failure due to normal usage of readers	
FR4		S2 and S4	(L, M) R4. Specialized IT Admin support may be required to manage RFID database	(H, L) N2. Decision to use database provided with typical installation will maintain integrity of ERP database
FR5	T1	S1 and S4	R1 and R4	N1

Table 12. Quality factors related to functional requirements

The team ranked each factor (H, M, and L) for likelihood of occurrence and degree of impact on operations if the “To-Be” model were implemented. They then plotted the factors in a matrix (Table 13) to gauge the feasibility of the “To-Be” model as a viable RFID candidate. A good candidate will show most or all trade-off/sensitivity points and risk and non-risk in or near the green area of plot. Service level agreements with the vendor can move factors that fall in the yellow area of the plot toward the green area. Factors that fall in the pink or red area of the plot could represent significant obstacles too difficult to mitigate in either scheduled delivery or cost to acquire for system implementation.

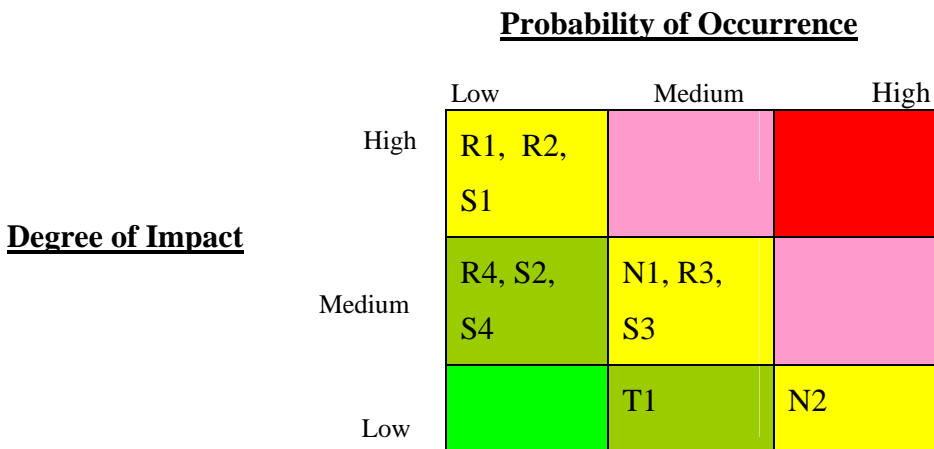

Table 13. Feasibility of To-Be as RFID candidate

b. Technology Maturity

The basis for weights used to assess quality factors relate to product availability of current RFID technology. Most of the factors primarily relate to the availability of mature RFID hardware, specifically readers and tags. Although several new products (such as WiFi RFID tags - Ekahau, ingestible RFID tags - Kodak, RFID powder - Hitachi, and the like) seem to emerge nearly every month. The weights assess the availability of products that have been stable in the market for over three years. According to reference ((Boone, 2004; Butler & Nti, 2005; EPCglobal US, 2006; Intermec, 2005; Reynolds & Weigand, 2005) resources, there are stable RFID products on the market that can achieve high accuracy of read robustness. There are also ruggedized readers in the consumer market that can withstand drops up to five feet on a concrete surface however, they cost somewhat higher than non-ruggedized readers. Overall standards such as EPCglobal UHF Gen 2 and ISO 18000.6C are driving the stability of product availability and interoperability.

c. Integration

For risk and sensitivity points that fall into the yellow area, the team rationalized that policy and documented standard operating procedures would move these closer to the green area. Factors such as T1 and R3 could move closer to the green area by establishing service level agreements with the vendor during contract negotiations. Considering all factors as a whole, the team consensus was that the “To-Be” model is a feasible candidate for RFID implementation.

d. Learning Curve on Training/Operation

RFID systems not employing middle/edge ware do not require specialized skill sets to maintain the RFID database. The team recalled that in two of the three case studies training for end-users was minimal, one hour. As for the IT administration for the system, the RMMS clerks could be trained to manage the system within the short period required to install the system; approximately two to three days.

4. To-Be Model Simulation

One of the team members had some experience in using the Extend version 6 software-modeling tools and developed a generic simulation (Imagine That Inc., 2002). A screen capture (Figure 24) of simulated model show below depicts how the checkout To-Be model would function. Since it may be rare that a team member possesses such skills there are vendors who will develop a simulation of a To-Be model. The vendor may even have a local lab that can show a prototype setup of how a To-Be model would function. At the very least taking, a tour of a vendor’s lab facility would pay dividends in seeing how a mock RFID system would operate in an environment that simulates your facility.



Figure 24. Screen capture of “To-Be” simulation

E. CONDUCT COST/BENEFIT ANALYSIS

1. Risk

Risks include hardware performance issues, technical feasibility and initial capital investment. Software and vendor support specifications require careful identification so that all costs are accounted for in the initial vendor bid. A strategy to mitigate risk would

be to include warranties and equipment servicing contracting, perhaps at no cost for the first year. Indications at the physical layer, show initial capital investment providing significant return on investment for funneling towards other resources.

a. Hardware Performance

The results of scenarios described in the ATAM analysis identified key performance issues. Using a checklist (Figure 25) can greatly reduce the risk of purchasing equipment that fails to meet stated requirements. Another way is a requirement that the vendor provide a simulation that shows a “To-Be” model in action. As mentioned from the case studies, the organizations conducted pilot projects well before making the decision for full implementation. Given that pilots represent a sample of the business process clearly defined functional and quality requirements for the pilot provides a practical snapshot of the overall system requirements.

Figure 1: User requirements for Gen 2 functionality checklist

	Product A	Product B	Product C
Can the product perform in dense reader mode?			
If no, expected cost to upgrade to dense reader mode			
Is persistence provided?			
Is group select supported?			
Is write verification performed?			
Can data be write protected?			
Is cloaking available?			
Is password protection available?			
Can the readers kill tags?			
Is remote management and configuration possible?			

Figure 25. Example of RFID system functionality checklist (From: Intermec, 2005b)

b. Software

RFID implementation has proven technological success for several types of organization that previously operated a manual item-tracking process. Implementation procedures are not difficult nor beyond present personnel capabilities. The highest risk resides in an adopted software package that is not functional, reliable, upgradeable, or

user-friendly. The software costs and licensing prices can prove almost as expensive as the hardware components in implementing a RFID solution. The cost unaccounted for in pricing relates to time and labor spent implementing software that is not user-friendly and easily learnable. Cost and time can spiral for after sale support if the software requires customization in order to integrate into an existing network infrastructure. Customized software could result in on-site vendor visits when upgrades require installation. A package that is easy to install and use is likely to show the positive benefits from implementation more quickly than one with a steep learning curve.

c. Technical Feasibility

Although there are several components that comprise the RFID system, a closed-loop system would offer, the best implementation for organizations that do not have external partners and cannot outsource due to restrictions of the Privacy Information Act. The organization described in this thesis cannot outsource their services due to the nature of information handled. The organization by law must protect the privacy of its records by using state hired personnel who are U.S. citizens. Thus, a closed-loop system using an additional server connected to the network for the RFID database poses no technical issues that would make the system impossible to implement over a minimal install period. The cases discussed in this thesis provide ample evidence that the implementation process is very doable with minimal impact to on-going operations.

2. Benefits

The primary objective of this thesis was to make the case for determining if a RFID technology provides advantage against a manual item-level tracking system that shows the potential for improving the efficiency of the business process. Well as demonstrated in the KVA analysis and ATAM evaluation of the “To-Be” model, transitioning the described business process provides the following benefits:

- Improved customer services,
- Enterprise visibility of items

- Reduction in over tasking personnel resources
- Improved operations efficiency

The results of these benefits reflect cost savings of salaries, capability to increase productivity and capturing tacit knowledge in automation, which is intellectual capital that remains with the organization regardless of personnel reassignments.

3. Return on Investment

a. Estimated Cost to Implement RFID

Using cost information from case studies (3M, 2005; 3M, 2006) and online resources (Boss, 2004; Sullivan, 2005; Swedberg, 2006); an example of broad cost estimates (Table 14) for a RFID implementation is shown below regarding a closed-loop system consisting of the following components:

- Pad type RFID reader attached workstations,
- Hand-held readers, RFID DB software,
- A server,
- Fixed readers with antennas,
- Cost for labor (in-house) in placing tags on the records and
- Incidental carpentry/electric work

The numbers represent a very broad scenario of RFID implementation. A tailored strategy would be subjective to the functional and quality attribute requirements of organization using the finding of this thesis. Table 15 shows the acquisition and monthly operating cost for conducting RMMS at each facility as based on the “To Be” workflow model.

35,000 tags @ \$.50	\$17,500
Workstation readers 6 @ \$800	\$ 4,800
Client-Server software	\$18,000
3 Hand-held @ \$7000	\$21,000
1 Server	\$2,000
Tag placement 150 hours of labor @ \$16.00/hour	\$2,400
Carpentry and electrical	\$1,500
Estimated Total:	\$67,200

Table 14. Example of cost estimate for RFID implementation

Facility	Inventory	Checkout	Acquisition Cost	Total
One	\$.3 M	\$1.8 M	\$.07 M	\$ 2.2 M
Two	\$.07 M	\$.4 M	\$.02 M	\$.49 M
Three	\$.2 M	\$1.3 M	\$.05 M	\$ 1.6 M
LMVO Total	\$ 0.6 M	\$ 3.5 M	\$.14 M	\$ 4.3 M

Table 15. Estimated acquisition and monthly cost of “To Be” operating cost by facility

b. Cost of Current System

Table 16 shows the monthly operating cost per facility based on the “As Is” workflow model. The cost reflected in acquisition and operations for the “To Be” system indicates a payback within one month. Although the cost indications represented are hypothetical, some of the companies discussed in the case studies and reference

articles have experienced similar ROI. The ‘*RFID in force at asset management expo*’ article in the RFID Update, 27 January 2007 issue states “...segments, like retail, have often remained in the pilot phase because they require broad trading partner adoption to achieve a return on investment (ROI). End users in the asset management space, however, have been able to forge ahead with successful, closed-loop deployments that pay for themselves relatively quickly.” (Smith, 2007)

Facility	Inventory	Checkout	Total
One	\$.9 M	\$3.9 M	\$ 4.8 M
Two	\$.2 M	\$.94 M	\$ 1.1 M
Three	\$.64 M	\$2.8 M	\$ 3.4 M
LMVO Total	\$ 1.7 M	\$ 7.6 M	\$ 9.3 M

Table 16. Estimated monthly cost of “As Is” operating cost by facility

For LMVO, a full item inventory involves manual confirmation for each item; a very personnel intensive. Each record requires visual verification by one person while other person marks an inventory sheet to indicate the record accounted for. With RFID, the capability for on-demand inventory is possible year-round. The time spent on searching for and locating missing items decreases dramatically, which would result in faster checkout times for customers. This elimination in the extensive use of personnel time spent looking for records frees-up personnel for more essential service oriented tasks.

V. CONCLUSION

A. DISCUSSION

The potential benefits and drawbacks outlined in this thesis lean toward the implementation of a radio frequency identification (RFID) system. The benefits of improved customer services, enterprise visibility in item-level tracking of records location and the elimination of extensive use of personnel time in looking for records/conducting inventory all outweigh the risks associated with RFID. The major obstacle facing an organization desiring to integrate RFID capabilities lie in the initial investment of primary cost drivers such as price per tag and software.

A decision to integrate with an existing ERP tool requires middle/edge ware, which can be quite costly. Even making the choice to use a separate database application along with a web-based visibility application may still require a hefty price for per seat/enterprise licenses. However, as technology advances, the cost for the individual tags will continue to decrease to perhaps as low as \$0.08 to \$0.10 per tag. Moreover, mainstream enterprise resource planning (ERP) vendors are evolving their tools to be RFID friendly, which would eliminate a need for middleware all together.

The realized return on investment for an RFID implementation could have a short payback period with a closed-loop system in organizations expending personnel resources at the level demonstrated in this thesis. Many vendors can offer solutions that can nearly mirror an organizations business culture while eliminating the extensive use of resources by reducing cycle times, i.e. delays that exist within the business process. Therefore, it is in the best interest (in both benefits and cost) of an organization that has a business process similar to the one described in this thesis to consider formulating a strategy to leverage a RFID solution for improving operations efficiency.

B. RECOMMENDATIONS

The recommended steps for an organization who has reviewed the findings of this thesis and considering leveraging RFID on a manual item-level tracking process are as follows:

- Map As-Is process and collect site data on cycle times for each sub-process approximately four to six weeks
- Develop a To-Be model based on steps that will be impacted by RFID, i.e. expect step(s) to be eliminated/reduced cycle times
- Evaluate To-Be model using an evaluation method like ATAM
- Choose a sub-process to pilot with a set number of records
- Solicit vendors and chose best fit based on requirements for pilot and ability to simulate the To-Be model
- Evaluate results of pilot for consideration of full RFID implementation

APPENDIX A – “AS IS” WORKFLOW MODEL: ITEM CHECKOUT SEGMENT

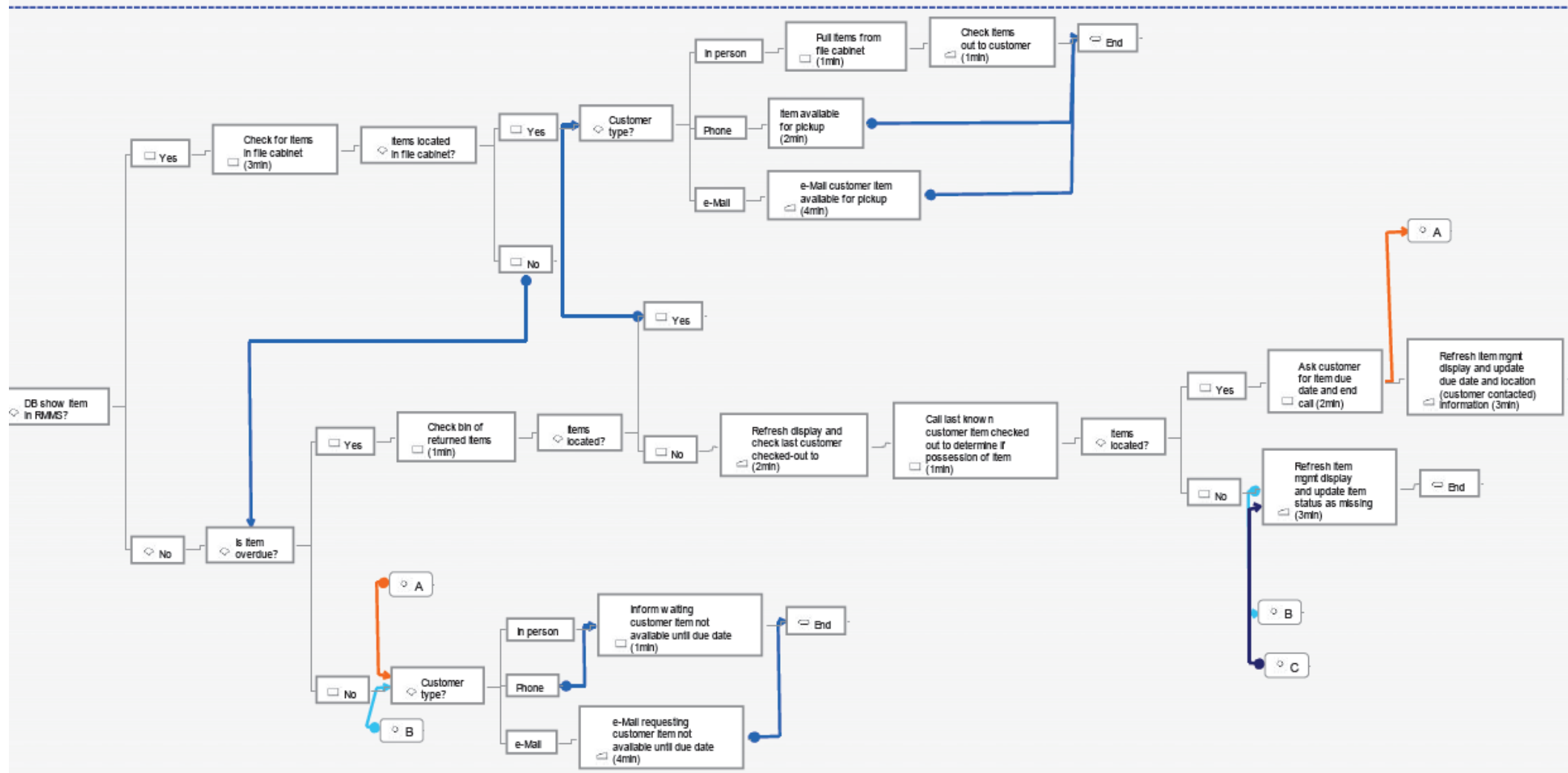

THIS PAGE INTENTIONALLY LEFT BLANK

APPENDIX B – “AS IS” WORKFLOW MODEL: ITEM CHECK-IN AND INVENTORY SEGMENTS

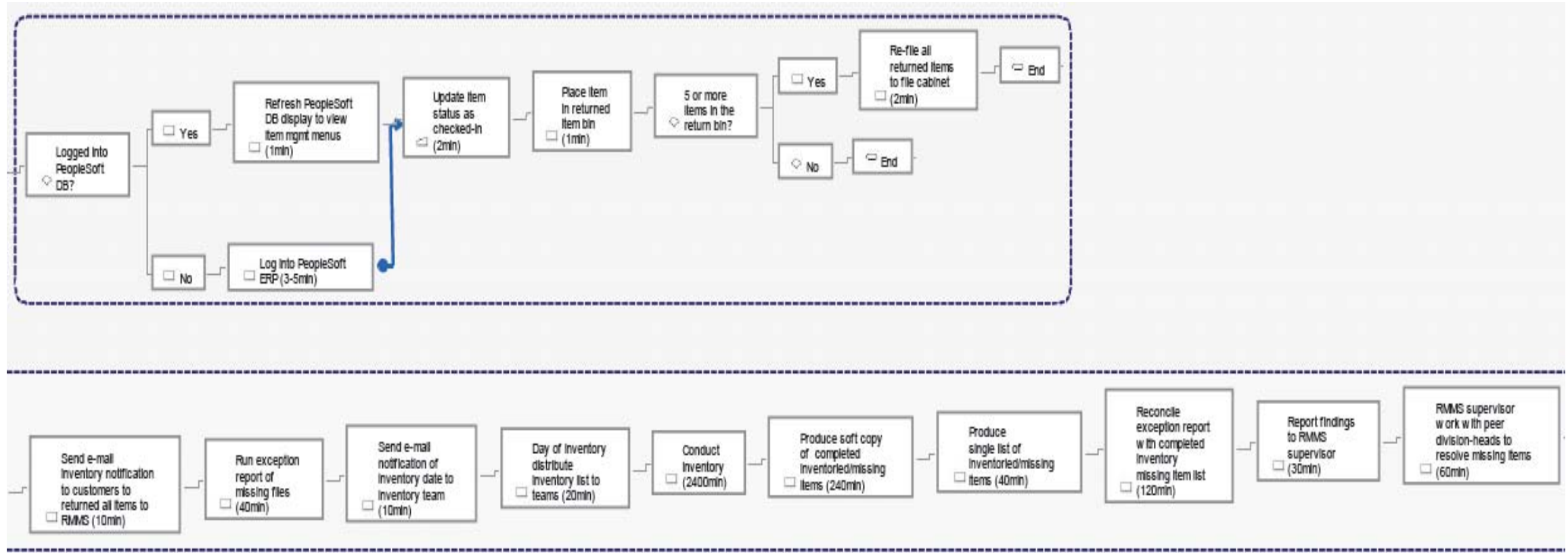

THIS PAGE INTENTIONALLY LEFT BLANK

APPENDIX C – “AS IS” INVENTORY AND ITEM CHECKOUT KVA ANALYSIS SPREADSHEETS

Inventory Completion Time 5280

Industry Revenue/hour \$ 16 **Total/month** \$ 139,615

Total reflects monthly portion of annual inventory cost of \$1.7M

Steps	ALT	Nbr of Employees	Amount Knowledge IT	Total Amount Knowledge units	% Total Knowledge	Market Comparable Revenue	Process Cost	ROK	Order of Magnitude
Clerk send LMVO inventory notification	15.00	3	5	50	1.12%	\$ 1,560	\$ 423	369%	4.32%
Clerk run exception report of missing items	90.00	3	41	311	7.01%	\$ 9,785	\$ 846	1156%	13.54%
Clerk send inventory team notification	15.00	3	5	50	1.12%	\$ 1,560	\$ 423	369%	4.32%
Clerk provide teams their list of items	1.50	3	0	5	0.10%	\$ 142	\$ 2,115	7%	0.08%
Two person team conduct inventory of listed items	115.00	20	0	2300	51.91%	\$ 72,478	\$ 913,462	8%	0.09%
Two person team produce soft copy of inventoried/missing items	45.00	20	90	990	22.35%	\$ 31,197	\$ 365	8538%	100.00%
Clerk merge inventoried/missing item lists	115.00	3	35	380	8.57%	\$ 11,959	\$ 212	5653%	66.21%
Clerk reconcile exception and inventoried missing reports	90.00	3	27	297	6.70%	\$ 9,359	\$ 635	1475%	17.27%
Clerk report findings to RMMS supervisor	12.50	3	0	38	0.85%	\$ 1,182	\$ 212	559%	6.54%
RMMS supervisor brief peer division heads on missing items	12.50	1	0	13	0.28%	\$ 394	\$ 808	49%	0.57%
Industry Comp ROI				4,431		\$ 139,615	\$ 919,500	15%	

Actual to Nominal Learning time Correlation 86%
 Note: all value expressed per month

Vee Courtney:
 Health Grade Inc in Staffing & Outsourcing
 industry; emp 106; rev \$26 mil(ttm)

Cost more to perform than revenue generated from this step

Target areas for improvement in To-Be

Records Processed/Month 1365

Minutes/Month Spent Looking for Items 1,384

Market Comparable Revenue/month \$ 1,126,420

Average Check-out time/item (min) 11.6

Steps	ALT	Nbr of Employees	Amount Knowledge Embedded in IT	Total Amount Knowledge units	% Total Knowledge	Market Comparable Revenue	Process Cost	ROK	Order of Magnitude
Customer request item per ERP showing available	7.50	120	90	990	39%	\$ 434,504	\$ 11,083	3920%	100.0%
Clerk verify item avail in record storage area	50.00	3	-	150	6%	\$ 65,834	\$ 1,155,000	6%	0.1%
Need to locate item	165.00	3	-	495	19%	\$ 217,252	\$ 300,300	72%	1.8%
Clerk enter customer badge number in ERP to begin check-out	90.00	3	41	311	12%	\$ 136,276	\$ 385,000	35%	0.9%
Clerk enter item id number in ERP against customer id number	90.00	3	41	311	12%	\$ 136,276	\$ 1,155,000	12%	0.3%
Clerk enter return date for all items charged to customer	90.00	3	41	311	12%	\$ 136,276	\$ 1,155,000	12%	0.3%
Customer receives items and exit RMMS records office	0.00	120	-	-	0%	\$ -	\$ -	0%	0.0%
Industry Comp ROI				2,567		\$ 1,126,420	\$ 4,161,383	27.1%	

Actual to Nominal Learning time Correlation 88%
 Note: all times, dollars expressed in minutes, dollars per month

Vee Courtney:
 EBIX Inc in the Bus Supp Svc
 industry; emp 229; rev \$26 mil(ttm)

Total intellectual and IT knowledge in this subprocess

ROK seven percent above industry ROI

Target areas for improvement in To-Be

THIS PAGE INTENTIONALLY LEFT BLANK

APPENDIX D – “TO BE” WORKFLOW MODEL: ITEM CHECKOUT SEGMENT

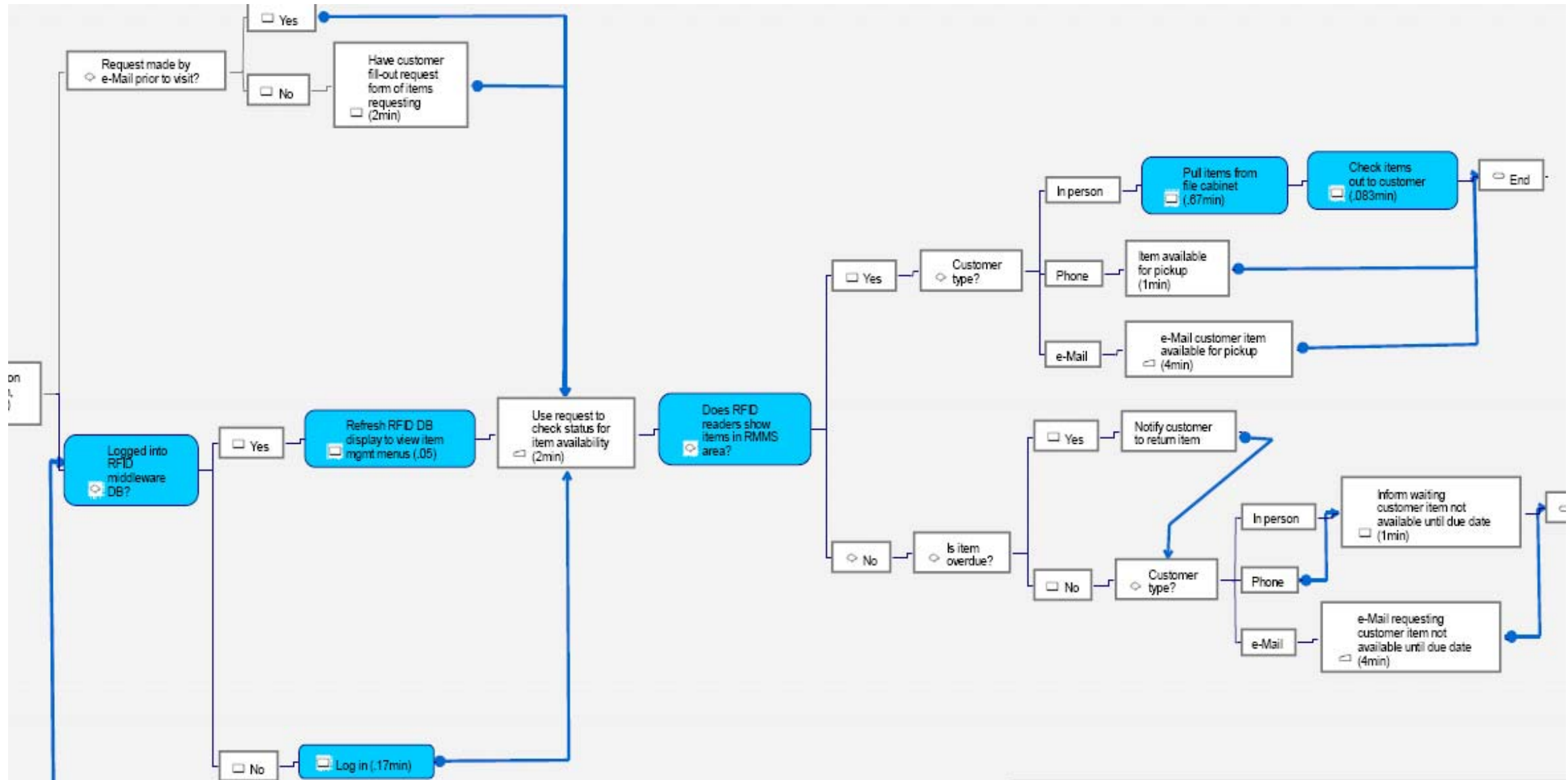

THIS PAGE INTENTIONALLY LEFT BLANK

APPENDIX E – “TO BE” WORKFLOW MODEL: ITEM CHECK-IN AND INVENTORY SEGMENTS

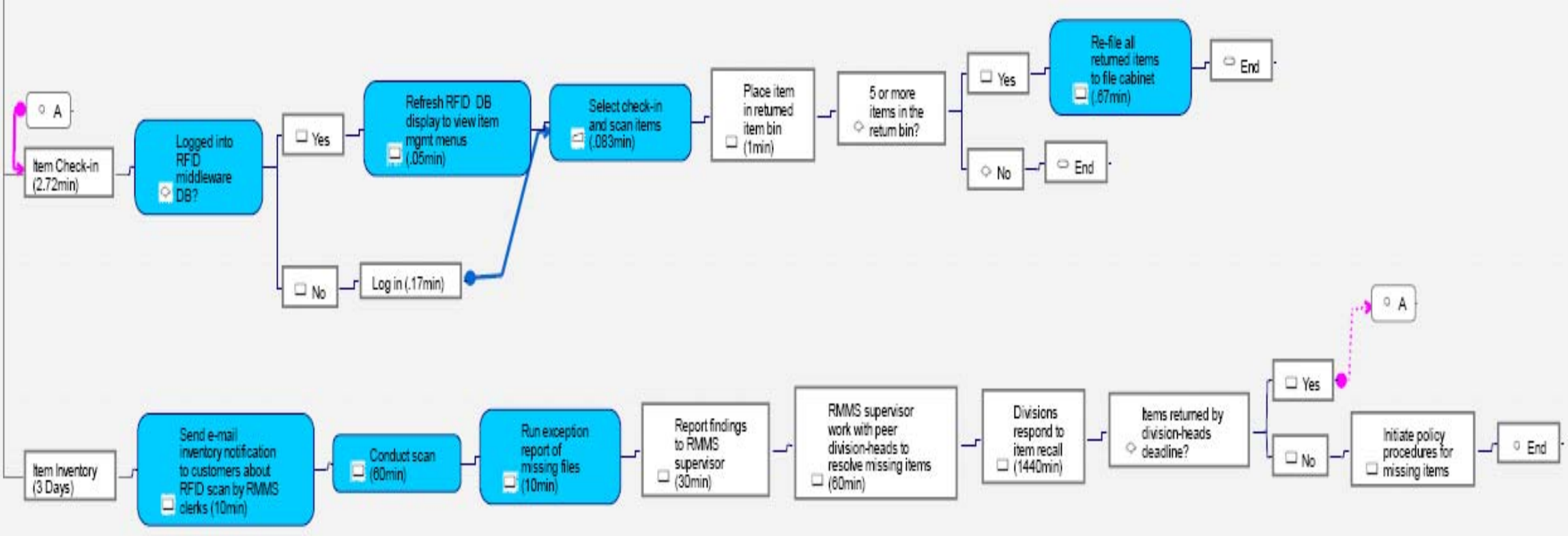

THIS PAGE INTENTIONALLY LEFT BLANK

APPENDIX F – “TO BE” INVENTORY AND ITEM CHECKOUT KVA ANALYSIS SPREADSHEETS

Inventory Completion Time 1440
 Industry Avg Revenue/hour \$ 16 Total/month 456,923

Steps	ALT	Nbr of Employees	Amount Knowledge Embedded in IT	Total Amount Knowledge units	% Total Knowledge	Market Comparable Revenue	Process Cost	ROK	RFID Impact	As-Is ROK	Industry Comp ROI
Clerk send LMVO inventory notification	15.00	3	5	50	3.56%	\$ 16,254	\$ 423	3842%	up	369%	26.2%
Clerk run exception report of missing items	70.00	3	168	378	27.16%	\$ 124,123	\$ 846	14669%	up	1156%	
Clerk conduct inventory of items	90.00	3	216	486	34.93%	\$ 159,587	\$ 277,115	58%	up	8%	
Clerk re-run exception report of missing reports	70.00	3	168	378	27.16%	\$ 124,123	\$ 277,115	58676%	up	1475%	
Clerk report findings to RMMS supervisor	25.00	3	-	75	5.39%	\$ 24,628	\$ 212	1119%	up	559%	
RMMS supervisor brief peer division heads on missing items	25.00	1	-	25	1.80%	\$ 8,209	\$ 808	1016%	up	49%	
TOTAL				1,392		\$ 456,923	\$ 279,615	163%			
				4,431		\$ 139,615	\$ 919,500	15%			

Actual to Nominal Learning time Correlation 95%
 Note: all value expressed per month

Estimate more evenly disbursed knowledge over difficult task resulting in reduced cycle time in completing an inventory evolution

Estimate achieving target primary objective of significantly lowering cost to conduct inventory by reducing times fired

Records Processed/Month 3275

Minutes/Month Spent Looking for Items 118

Market Comparable Revenue/month \$ 2,702,582

Average Check-out time/item (min) 3.0 vs 11.6

Steps	ALT	Nbr of Employees	Amount Knowledge Embedded in IT	Total Amount Knowledge units	% Total Knowledge	Market Comparable Revenue	Process Cost	ROK	RFID Impact	As-Is ROK	Industry Comp ROI
Customer request item per web-enabled view of availability	10.00	120	300	1,500	42%	\$ 1,140,090	\$ 15,955	7146%	up	3920%	21.2%
Clerk verify item avail in record storage area	15.00	3	36	81	2%	\$ 61,565	\$ 27,656	223%	up	6%	
Need to locate item	115.00	3	276	621	17%	\$ 471,997	\$ 166,269	284%	up	72%	
Clerk scan customer badge number to begin check-out	95.00	3	228	513	14%	\$ 389,911	\$ 554,231	70%	up	35%	
Clerk scan items against customer id number	95.00	3	228	513	14%	\$ 389,911	\$ 554,231	70%	up	12%	
Clerk enter return date for all items charged to customer	95.00	3	43	328	9%	\$ 249,110	\$ 554,231	45%	up	12%	
Customer receives items and exit RMMS records office	0.00	120	-	-	0%	\$ -	\$ -	0%		0%	
TOTAL	425			3,556		\$ 2,702,582	\$ 1,872,573	144.3%			
				2,567		\$ 1,126,420	\$ 4,161,383	27%			

Actual to Nominal Learning time Correlation 81%
 Note: all times, dollars expressed in minutes, dollars per month

Estimate decreasing customer wait time and increasing visibility of item location by providing multiple item scans and having customers update item location in web-based tracker

Estimate increasing all ROK values by lower in revenue to cost ratios

Estimate reducing cost by lower times fired and increasing revenue by serving more customer due to reduced time spent looking for records

Assumptions:

Analysis based on facility one as a baseline for other facilities	
RMMS Supervisor - \$41K/yr; 4 yrs exp	\$42,000
RMMS Clerk - \$26K/yr; 3 yrs exp	\$33,000
License Processor - \$38K/yr; 3 yrs exp	\$38,000

Known Facts:

Documented statics

Avg cycle time spent looking for item(min)	0.6
% Item not in location as indicated in RFID system	6%
Avg cycle time to refresh Item mgmt menu(min)	0.3

Subp-process Cost Calculation

Steps	Times Fired/Month
Customer request based on web-enabled item avail view	5

THIS PAGE INTENTIONALLY LEFT BLANK

APPENDIX G – MIND MAP OF RFID IMPLEMENTATION OPTIONS

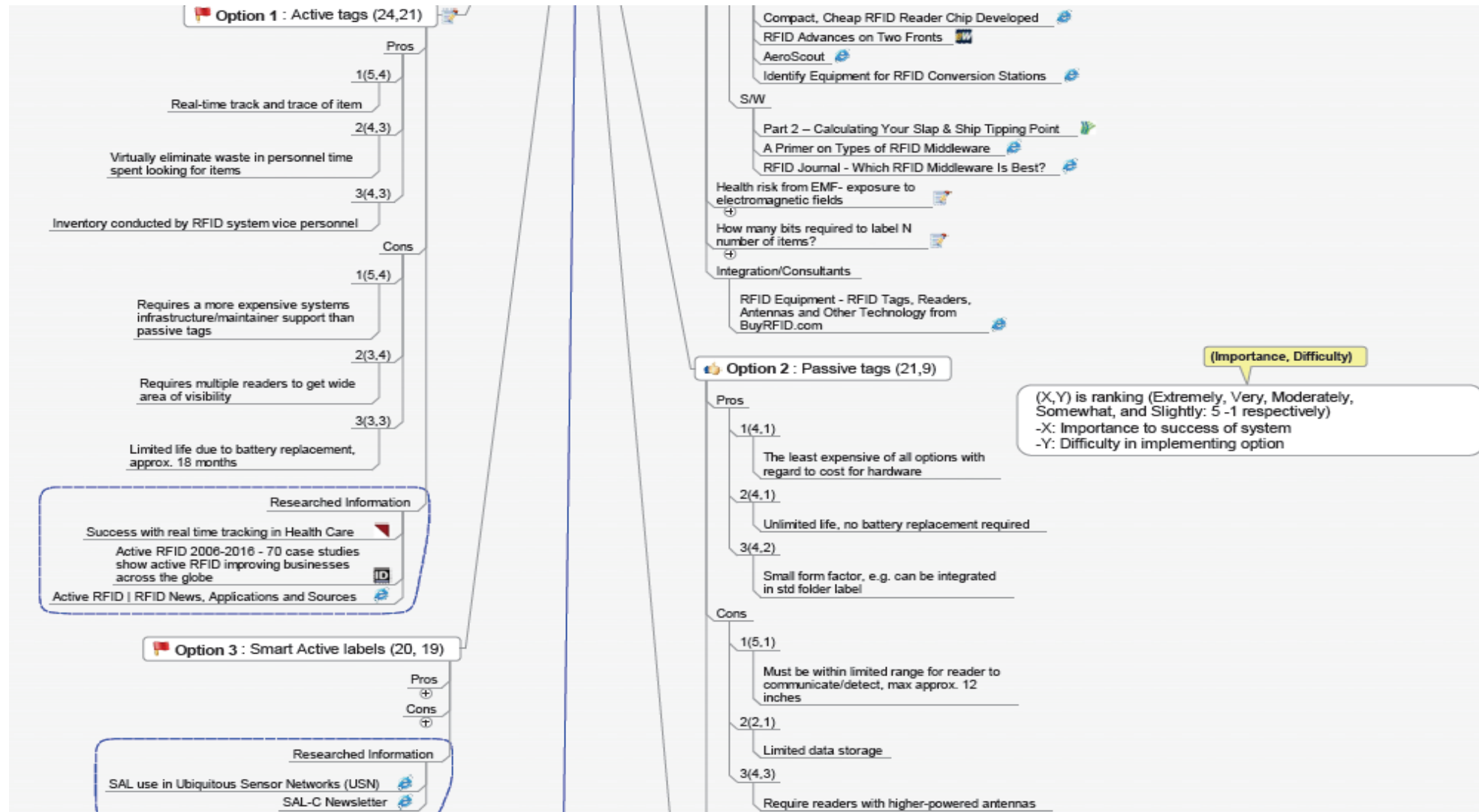

THIS PAGE INTENTIONALLY LEFT BLANK

APPENDIX H – UTILITY TREE OF QUALITY ATTRIBUTES

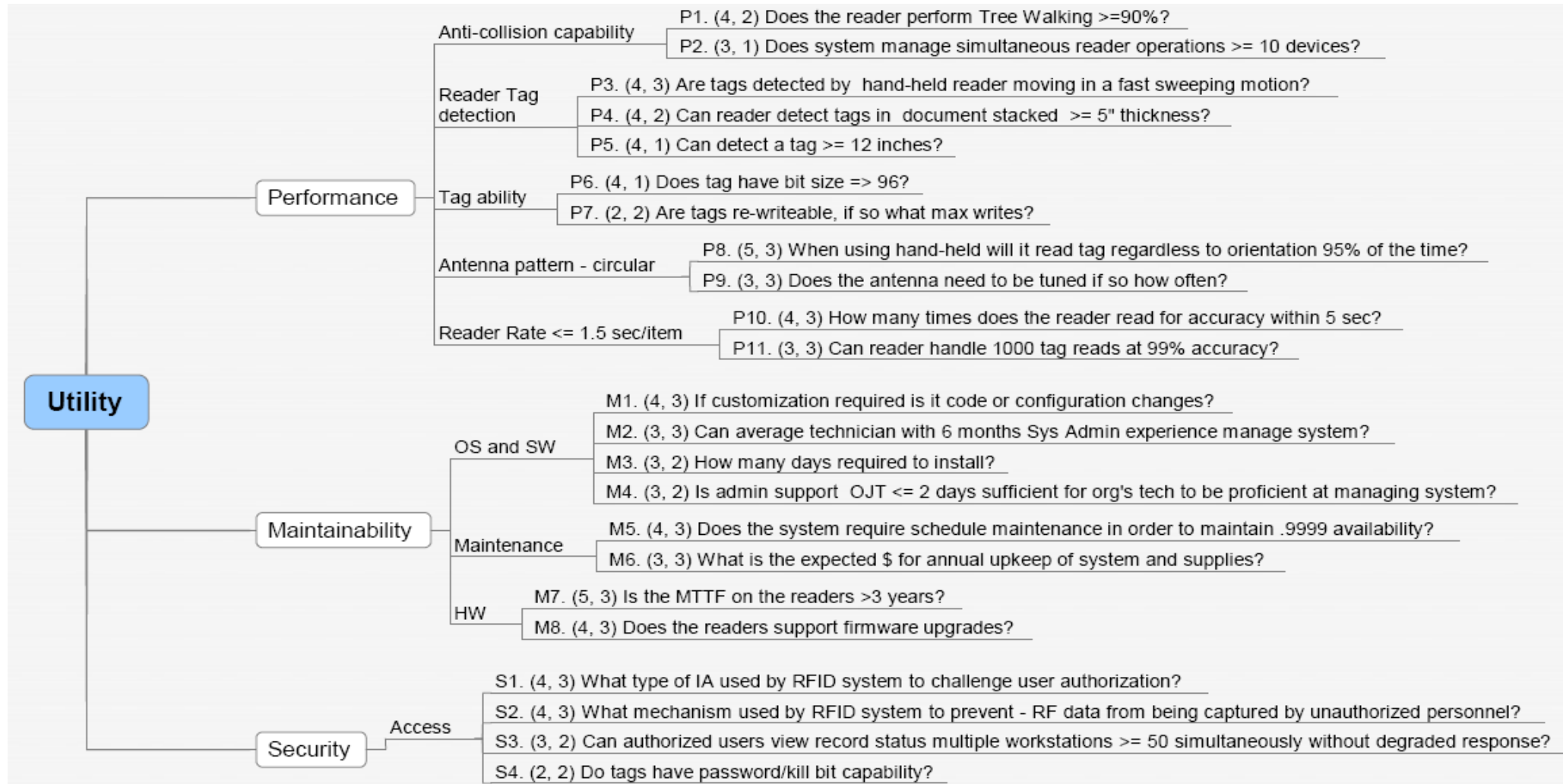

THIS PAGE INTENTIONALLY LEFT BLANK

LIST OF REFERENCES

- 3M (2006). 3M Security - *3M Security - What's New: The law firm of Fish and Richardson extends 3M RFID file tracking system to its offices nationwide*. Retrieved January 3, 2007, from <http://www.3m.com/security/en/fr rollout release.html>.
- 3M (2005). 3M Security - *What's New: Florida State University puts 3M's radio frequency identification system to work on behalf of its sponsored-research grants*. Retrieved January 3, 2007, from <http://www.3m.com/security/en/fsurfid.html>.
- Albanese, A. (2006). *Map dealer admits thefts* Reed Business Information (US).
- Annett, T. (2006). *Settling security*. *The Wall Street journal*, (Eastern Edition).
- Beer, M. (1988). *Leading change*. Boston, MA: Harvard Business School.
- Blossom, P. (2005, January 24, 2005). Levels of RFID maturity, part 2. Retrieved November 3, 2006, from <http://www.rfidjournal.com/article/articleview/1347/1/82/>.
- Boone, C. (2004). *RFID: The next big thing?* (IDC ed.). Washington, DC: Federal Trade Commission. Retrieved January 13, 2007, from <http://www.ftc.gov/bcp/workshops/rfid/boone.pdf>.
- Boss, R. W. (2004). *RFID technology for libraries*. Retrieved February 3, 2007, from <http://www.ala.org/PrinterTemplate.cfm?Section=technotes&Template=/ContentManagement/HTMLDisplay.cfm&ContentID=68138>.
- Butler, K., & Nti, A. (2005). *RFID reader system*. Boston, MA: Web.MIT.edu. Retrieved February 3, 2007, from http://web.mit.edu/6.111/www/f2005/projects/kabutler_Project_Design_Presentation.pdf.
- Clements, P., Kazman, R., & Klein, M. (2002). *Evaluating software architecture: Methods and case studies*. Boston, MA: Addison-Wesley.
- DATA & Corporate Culture Group (2007). *RFID smart label and tag solutions*. Retrieved February 2, 2007, from <http://www.ccgcommunications.com/thermal-pos.htm>.
- EPCglobal US (2006). EPCglobal U.S. conference 2006. *EPC Essentials*, Los Angeles, CA.
- EPCglobal US. (2006b). EPCglobal U.S. conference 2006. *Learning from the Field Sessions: Asset Management, Work in Process Manufacturing*, Los Angeles, CA.
- Garfinkel, S., & Rosenberg, B. (Eds.). (2006). *RFID: Applications, security, and privacy*. Upper Saddle River, NJ: Addison-Wesley.

- Housel, T., & Bell, A. H. (2001). *Measuring and managing knowledge*. Boston, MA: McGraw-Hill/Irwin.
- Hoovers Dunn and Brad Street (2007a). *Business services overview*. Retrieved January 28, 2007, from http://www.hoovers.com/industry/business-services/--HICID_1054--/free-ind-factsheet.xhtml.
- Hoovers Dunn and Brad Street (2007b). *Information & records management services information and related companies from Hoover's*. Retrieved January 28, 2007, from http://www.hoovers.com/industry/information-&-records-management-services/companies/-HICID_1074,Page_1--/free-ind-companies.xhtml?HICID=1074&Page=2&SiteDisplay=F.
- Imagine That Inc. (2002). *Extend v6 User's Guide*. San Jose, CA: Imagine That Inc.
- Intermec (2005a). *RFID basics for retailers* (Whitepaper). Everett, WA: Intermec. Retrieved January 28, 2007.
- Intermec (2005b). *Why Gen 2 Is the RFID for CPG manufacturers and how to make sure gen 2 performance will meet their needs* (Whitepaper). Everett, WA: Intermec. Retrieved January 28, 2007, from http://epsfiles.intermec.com/eps_files/eps_wp/WhyGen2forRFID_wp_web.pdf.
- J. Gold Associates. (2005). The mobile data loss epidemic. *Technology brief...* Northborough, MA: J. Gold Assoc. Retrieved February 14, 2007, from http://www.jgoldassociates.com/Technology_Brief/Technology_Brief_5_June_06.pdf.
- Jick, T. D., & Peiperl, M. A. (2003). Implementing change. *Managing change: Cases and concepts* (2nd Edition ed., pp. 229-241). New York, NY: McGraw-Hill.
- Kakesako, G. K. (2002, October 19, 2002). Navy missing computers. *Honolulu Star-Bulletin*, p. A1.
- Klein, R. (2007). *Can RFID deliver the goods?: A Manufacturer's visibility into supply and demand* (Benchmark Report No. 1). Boston, MA: Aberdeen Group. Retrieved February 15, 2007, from http://www.aberdeen.com/summary/report/benchmark/RA_RFIDMFG_3758.asp.
- Lahiri, S. (2006). *RFID Sourcebook*. Upper Saddle River, NJ: IBM Press.
- Lee, C., & Brulliard, K. (2006, August 6, 2006). 2 MD men arrested in theft of VA laptop juvenile is also a suspect in crime. *The Washington Post*, p. C1.
- Mairs, J. (2002). *VPNs: Planning your security approach. A beginner's guide*. Berkeley, CA: McGraw-Hill/Osborne.

- Mindjet Corp. (2007). *Mindjet software for visualizing information*. Retrieved January 1, 2007, from <http://www.mindjet.com/us/>.
- Mintzberg, H. (1981). *Organization design: Fashion or fit?*. Boston, MA: Harvard Business Review.
- Payscale.com (2007). *File clerk salary, average salaries*. Retrieved February 27, 2007, from http://www.payscale.com/research/US/Job=File_Clerk/Salary.
- Reynolds, M., & Weigand, C. (2005, August 4, 2005). Design considerations for embedded software-defined RFID readers. [Electronic version]. *RF Design*, (August 2005) 15. Retrieved February 2, 2007.
- RFID Update.com (2006). *Top 10 RFID Trends of 2006, Part 2*. Retrieved February 3, 2007, from <http://www.rfidupdate.com/articles/index.php?id=1266>.
- Silberglitt, R., Antón, P. S., Howell, D. R., & Wong, A. (2006). *The global technology revolution 2020 in-depth analyses: Bio/Nano/Materials/Information trends, drivers, barriers, and social implications* (Technical Report No. RAND_TR303). Santa Monica, CA: RAND Corporation. Retrieved January 12, 2007, from http://www.rand.org/pubs/technical_reports/TR303/.
- Smith, W. (2007). RFID in force at asset management expo. *RFID Update, February* (546), February 27, 2007. Retrieved February 27, 2007, from <http://www.rfidupdate.com/articles/index.php?id=1306>.
- Sun (2007). *Sun java RFID software*. Retrieved February 3, 2007, from <http://www.sun.com/software/products/rfid/index.xml>.
- Sullivan, L. (2005, January 24). Georgia court system hopes to trial RFID - news by InformationWeek. [Electronic version]. *InformationWeek, Article id# 57703442* (January) Retrieved February 20, 2007.
- Swedberg, C. (2006). *RFID journal - Maryland court tries UHF RFID file-tracking system - RFID (radio frequency identification) technology news & features*. Retrieved January, 3, 2007, from <http://www.rfidjournal.com/article/articleview/2582/1/1/>.
- TagSense.com (2006). *TagSense, RFID, sensors, chipless, consulting, development, vendor*. Retrieved 12 February, 2007, from <http://www.tagsense.com/ingles/faq/faq.html>.
- TEC (2004). *Radio frequency identification (RFID) product rating reports*. Retrieved February 5, 2007, from <http://rfp-templates.technologyevaluation.com/rfi.asp?modelid=226&catid=RFID>.
- U.S. Office of Personnel Management (2005). *Investigations Reimbursable Billing Rates for FY 2006 – FIN 05-02*. Retrieved February 5, 2007, from <http://www.opm.gov/extra/investigate/Fin-2005/fin05-02.asp>.

Want, R. (2006, February 2, 2006). An introduction to RFID technology. *Pervasive Computing*, (January-March 2006) 25.

Webex Communication, Inc. (2007). Partner Profile: Mindjet homepage. Retrieved January 1, 2007, from <http://www.webex.com/partners/partner-profiles.html?id=p70/>.

INITIAL DISTRIBUTION LIST

1. Defense Technical Information Center
Ft. Belvoir, Virginia
2. Dudley Knox Library
Naval Postgraduate School
Monterey, California
3. Erika Proctor
National Security Agency
Fort Meade, Maryland
4. Glenn R. Cook
Naval Postgraduate School
Monterey, California
5. Richard D. Bergin
Naval Postgraduate School
6. Valencia Courtney
U.S. Northern Command
Colorado Springs, Colorado